

MicroGuard[®] 586

**Rated Capacity Indicator System
for Truck-Mounted Cranes**

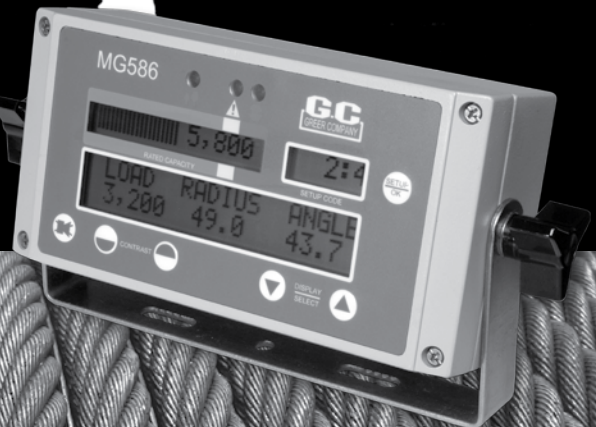

**Operation
Setup
Maintenance**

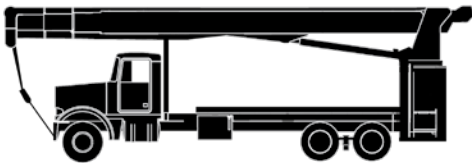

Consider Yourself Warned.™

Table of Contents

Introduction.....	1
System Description	2
Operator's Display Console.....	4
Warning/Alarm Indicators.....	4
Display Windows.....	4
Push Buttons	5
System Operation.....	6
System Self-Test.....	6
Configuration Selection.....	7
Normal Operation.....	8
Approaching Overload	9
Maximum Capacity and Overload	9
Two-Block Warning.....	10
Alarm Override.....	10
Adjusting the Contrast.....	11
System Calibration	12
Why Calibrate the System?.....	12
Required Tools	12
Adjusting the Sensors	13
Extension Cable Guides	13
Installing the Reel-Off Cable.....	14
Adjusting the Extension Sensor	14
System Self-Test.....	15
System Self-Test.....	15
Configuration Selection.....	16
Entering Setup Mode	17
Boom Angle System Zero	18
Boom Extension System Zero	18
Angle Span System Set.....	19
Boom Length Trim	19
Viewing Rope and Cable Limits	20
Jib Selection Setup (Interlock)	21
System Maintenance	22
Crane configuration and system setup.....	22

Extension reel, Reel-off cable to boom tip, extension reel cable to computer	22
Hydraulic connections	23
Anti-two-block weight.....	23
Anti-two-block switch.....	23
Checking the two-block warning signals and cutout of machine motions	23
Computer Cable	24
Load Test.....	24
Appendix A - Troubleshooting	A-1
System Fault Messages	A-1
Computer Replacement.....	A-3
Extension Reel Voltage Checks	A-4
Appendix B - Computer Troubleshooting.....	B-1
Computer Internal Status Indicators	B-1
Power Indicator States and Actions.....	B-2
Communication Indicator	B-2
Start-up Problems.....	B-3
Appendix C – Error Codes.....	C-1
Grouped Error Codes.....	C-1
Group “A” Faults.....	C-2
Group “B” Faults.....	C-2
Group “C” Faults.....	C-2
Group “D” Fault.....	C-2

Introduction

Congratulations on choosing the MicroGuard® 586 Rated Capacity Indicator/Limiter System.

The MicroGuard® 586 System is designed for use as an aid to crane operation. Do not use this system in place of an operator who is knowledgeable in safety guidelines, crane capacity information, and the crane manufacturer's specifications.

This manual describes the setup, operation, and maintenance of the MicroGuard® 586 Rated Capacity Indicator/Limiter System (hereinafter referred to as "the system"). Please make sure to read, understand, and follow the contents and instructions contained within this manual. The operator will then have a clear indication of rated capacity, approach to overload, and two-block conditions.

IMPORTANT!

IMPROPER INSTALLATION OF THIS SYSTEM CAN RESULT IN SYSTEM MALFUNCTION!

System Description

The system includes a computer, an operator's display console, an extension reel, and various cables and sensors; and is designed to measure and display load weight, calculate and display maximum capacity and percent of rated capacity, display code configuration numbers, and warn of an approaching overload or two-block condition for each crane configuration.

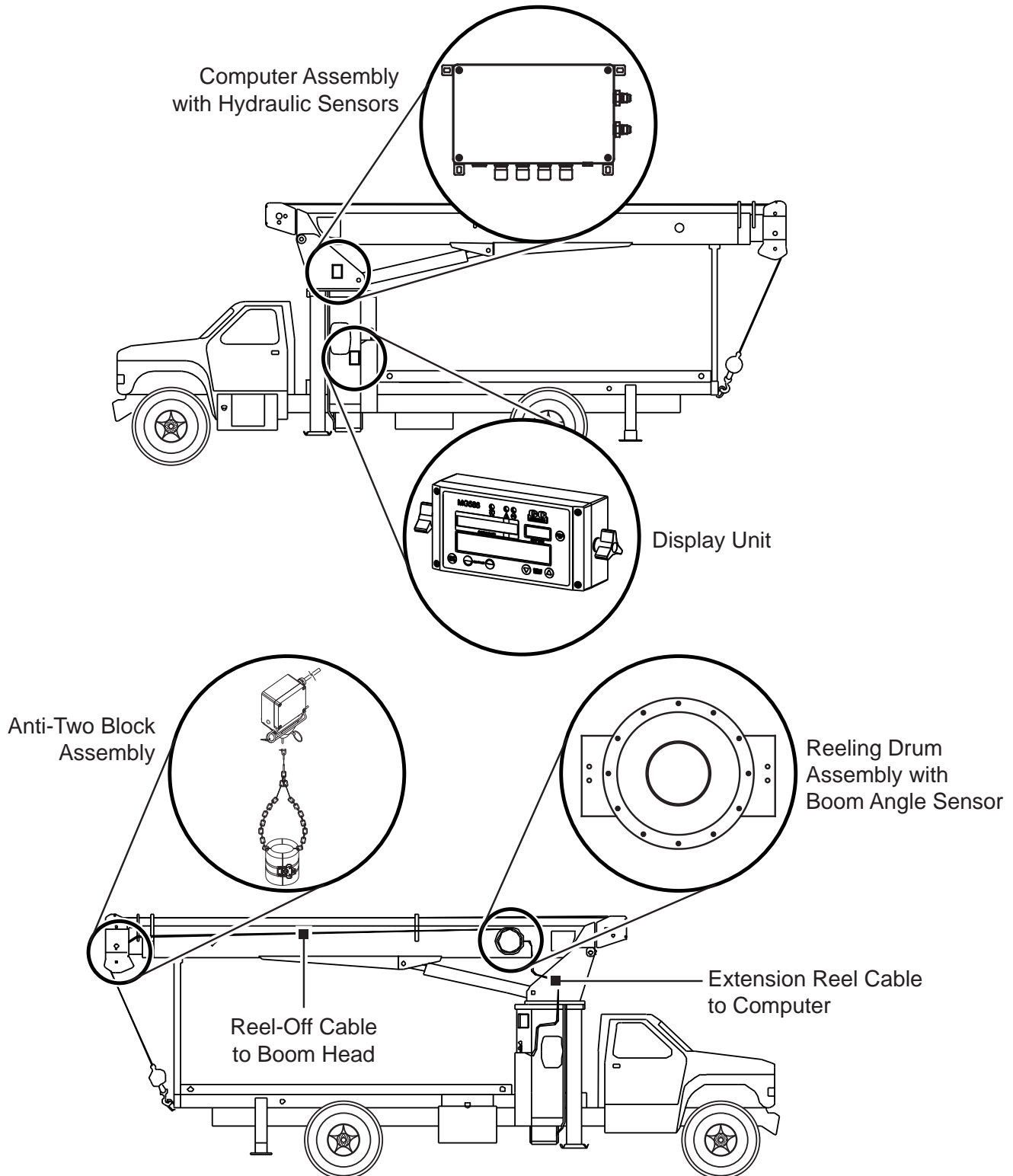

The **computer assembly** provides all of the functions necessary to read the system sensors, work out computations, and control the disconnect functions. In order to reliably calculate crane parameters, such as load and rated capacity, and interpret the crane capacity chart and code configuration numbers, information defining the physical characteristics of the crane has been loaded during factory setup.

Two **hydraulic pressure sensors**, housed in the computer assembly, measure the pressure in both sides of the boom hoist cylinder. Other system sensors, mounted elsewhere on the crane, are connected to the computer via electrical cables.

The **reeling drum assembly** measures the extended length of the telescoping sections of the boom and enables calculation of crane radius, load weight, and percent rated capacity.

The **anti two-block switch** is used to signal a possible two-block condition.

The **reel-off cable** provides a path, from the boom head to the computer via the extension reel cable. This path is used to send a two-block signal to the computer.

The **extension reel cable** provides a path to the computer for the two-block signal, the angle sensor, and the extension sensor.

The **boom angle sensor** is housed within the reeling drum assembly and measures the angle of the boom.

The operator's **display unit** translates data received from the computer and displays the actual load and percent of rated capacity in the display console windows. Visual and audible warnings and alarms activate when capacity limits are approached or exceeded, or when a two-block condition is encountered.

Operator's Display Console

Warning/Alarm Indicators

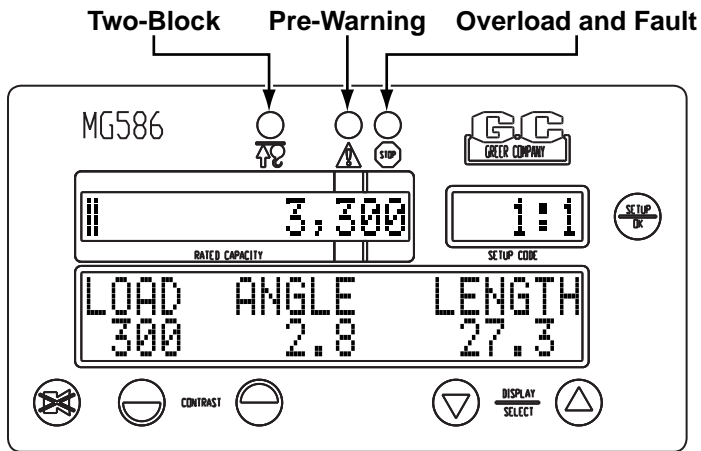

The red two-block lamp will illuminate when a two-block condition occurs (see “Two-Block Warning” on page 10).

The yellow pre-warning lamp will illuminate at 90% of rated capacity (see “Approaching Overload” on page 9).

When the load reaches or exceeds 100% of rated capacity, the red overload warning lamp will illuminate along with the yellow pre-warning lamp (see “Maximum Capacity and Overload” on page 9).

Display Windows

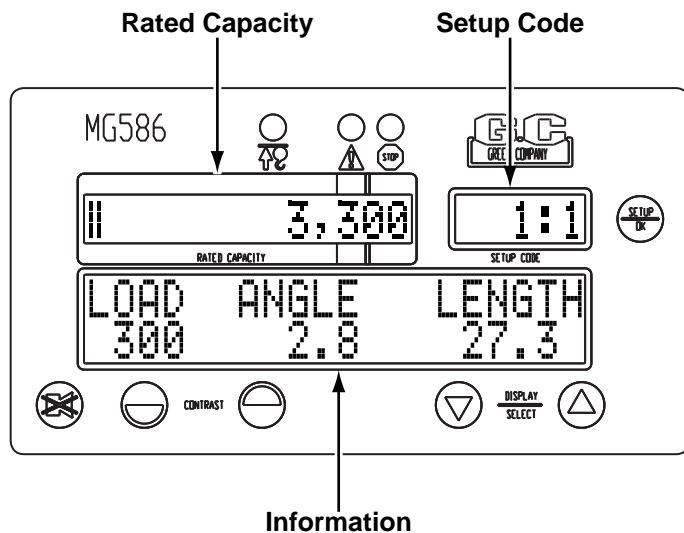

The current rated capacity for the crane in the current configuration will be displayed in the rated capacity window as well as the percent of rated capacity shown as a meter which progresses to the right as the load increases (see “Normal Operation” on page 8).

The setup codes are shown in the setup code window, as well as the parts-of-line, and the stowed jib option if available (see “Configuration Selection” on page 7).

The information window shows crane specific information regarding boom length, boom angle, and working radius, along with the load on hook. In addition, information regarding any

warnings or alarms will be displayed in this window. If the system has any internal faults, it will display “!WARNING! SYSTEM FAULT” in the information window. The specific fault messages can be viewed by pressing the **UP ARROW** or **DOWN ARROW** key (see “System Fault Messages” on page A-1).

Push Buttons

The **SETUP** key enables the operator to configure the system to match the actual setup of the crane. Codes are present for:

- stowed jib attachments; if no stowed options are available, this code will not appear
- crane configuration
- number of parts-of-line

The **ALARM OVERRIDE** key is used to disable the audible warning and to override the function kick-out for the current alarm condition.

The **CONTRAST** keys are used to adjust the lightness or darkness of the display area.

The **DISPLAY MODE/SELECT** keys are used to switch to different display formats showing various combinations of boom angle, boom length, and radius. They can also be used as an **UP ARROW** or **DOWN ARROW** key to scroll through menu selections.

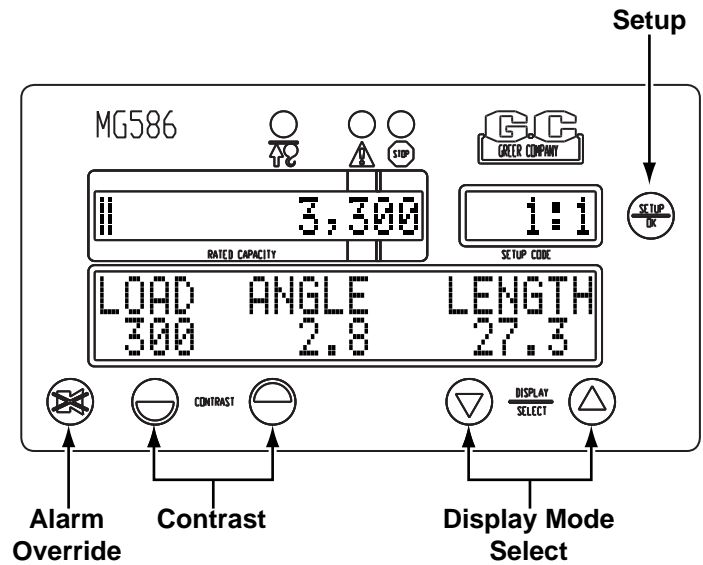

System Operation

System Self-Test

When the system is turned on, it goes through a brief self-testing process.

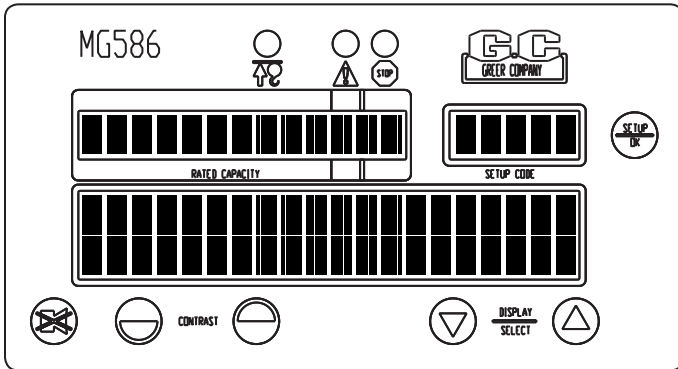

All three alarm indicators will light up, all display windows will appear black, and the audible alarm will sound.

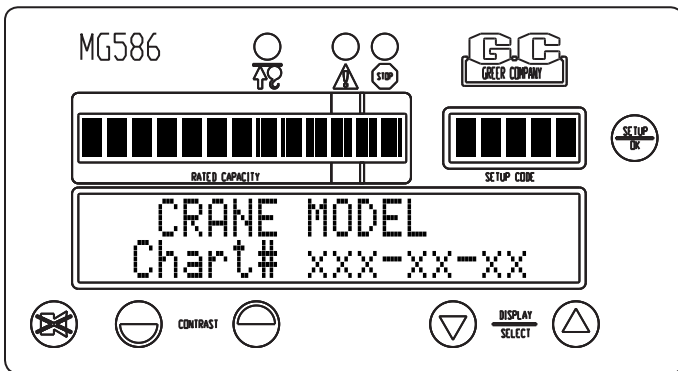

The information display will then show the crane model and capacity chart number for the system configured.

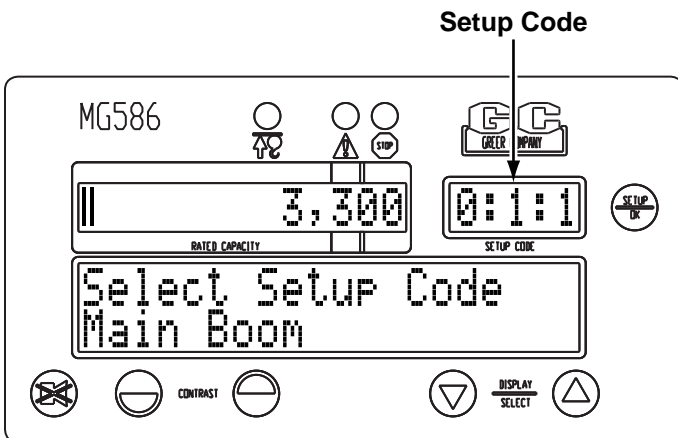

Following self-test, the system will go into the setup mode. The setup code window will display the same setup code used when the system was last powered off. Check that the correct setup code is displayed before operating the crane. Refer to "Configuration Selection" on page 7 for code setup instructions.

Configuration Selection

Configuration selection is required upon system power up; however, it can also be entered anytime by pressing the **SETUP** key.

The first stage allows selection of the stowed jib code.

Note: If no stowed jib options are available, this selection option is skipped.

The current stowed jib code will be flashing and the jib description is displayed in the information window.

To select a different stowed jib, press the **UP ARROW** or **DOWN ARROW** key to display the desired option and press the **SETUP/OK** key to continue.

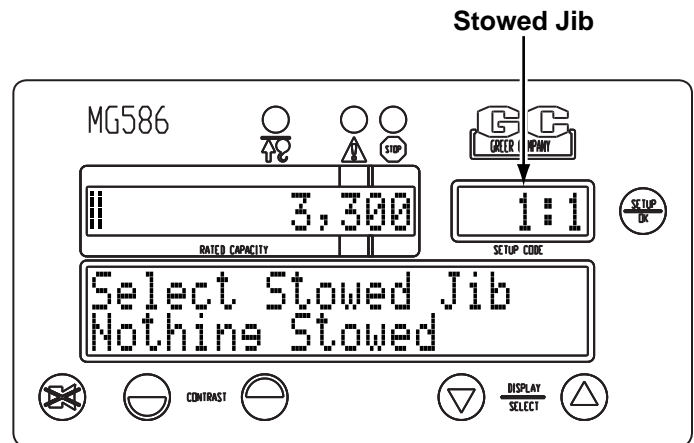

The current number of parts-of-line is now flashing.

To change the parts-of-line, press the **UP ARROW** or **DOWN ARROW** key to select the desired number and press the **SETUP/OK** key to continue.

Note: Some configurations allow only single part-of-line operation. In these cases, the whole parts-of-line selection phase will be skipped and the parts-of-line will be set to one (1).

Once the correct parts-of-line are entered, the system will exit the configuration mode and return to the normal working screen.

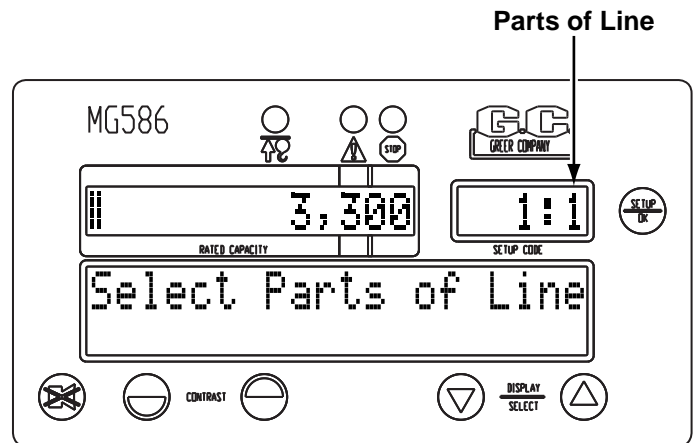

Normal Operation

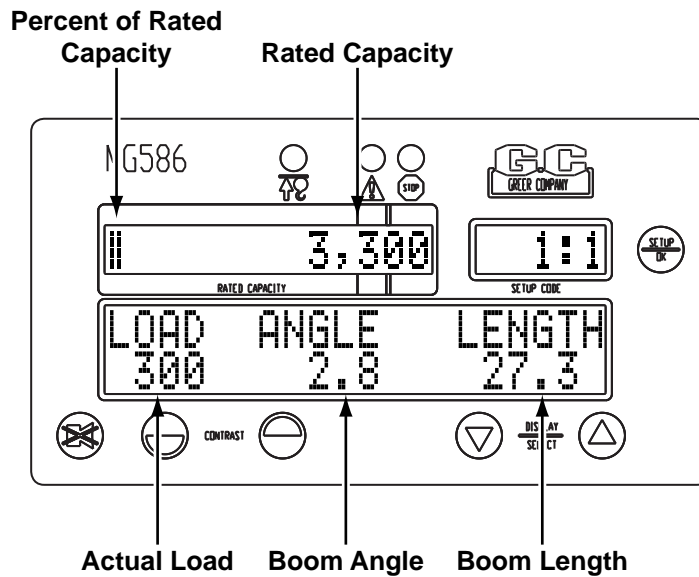

Percent of rated capacity indicates how near the operation is to full capacity and overload. The percent of rated capacity meter progresses to the right as the percentage increases. As long as the meter remains within the normal (green-bordered) zone, the percent of rated capacity is within normal operating limits. When the percent of rated capacity exceeds 60%, the rated capacity text will move to the left (see “Approaching Overload” on page 9).

Rated capacity is the heaviest load that the crane can lift in the current crane position and configuration. This value may be limited by the number of parts-of-line selected.

The **actual load** appears in the information window under the word “LOAD”. The actual load includes the weight of the load plus the weight of everything hanging below the boom tip (hook block, etc.).

The **boom angle** appears in the information window under the word “ANGLE”. This shows the current angle of the boom in degrees and tenths of a degree. Depending on the operation, the “ANGLE” display will change to “RADIUS”, in which case the radius from the centerline of rotation to the center of the suspended load will be shown in feet and tenths of a foot.

The **boom length** is displayed in the information window under the word “LENGTH”. This shows the current length of the boom in feet and tenths of a foot. By pressing the **UP ARROW** or **DOWN ARROW** key, the display can be changed to show “ANGLE” or “RADIUS”.

If the system has any internal faults, it will display “!WARNING! SYSTEM FAULT” in the information window. The specific fault messages can be viewed by pressing the **UP ARROW** or **DOWN ARROW** key (see “System Fault Messages” on page A-1).

⚠WARNING

THE OPERATOR MUST SELECT THE CORRECT CRANE CONFIGURATION CODE NUMBER FOR EACH SETUP CONFIGURATION CHANGE. INACCURATE OR NON-SELECTION OF THE APPROPRIATE CODE NUMBER WILL RESULT IN INCORRECT CALCULATIONS AND READINGS OF THE ACTUAL LOAD WEIGHT AND PERCENT OF RATED CAPACITY. REFER TO “CONFIGURATION SELECTION” ON PAGE 7.

Approaching Overload

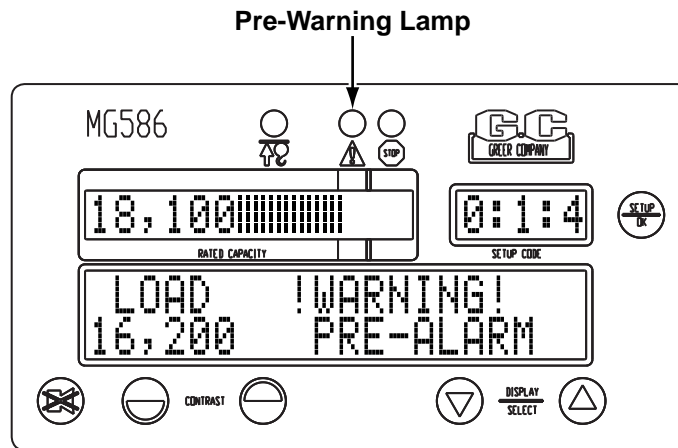

The system continuously monitors the weight of the load suspended below the boom head. The system compares this information with rated capacity data stored within the computer.

When the rated capacity of the configuration reaches 90%, the percent of rated capacity meter progresses from the normal (green-bordered) zone into the caution (yellow-bordered) zone.

A pre-warning lamp will illuminate and an audible alarm will beep continuously. The message “!WARNING! – PRE-ALARM” will flash in the information window.

Maximum Capacity and Overload

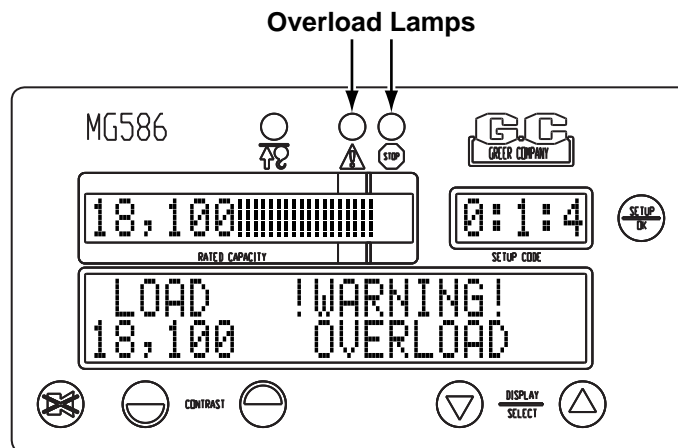

When the rated capacity of the crane reaches 100%, the percent of rated capacity meter moves from the caution (yellow-bordered) zone into the warning (red-bordered) zone.

The overload lamps will illuminate and an alarm will sound continuously. The message “!WARNING! – OVERLOAD” will flash in the information window.

Crane motions (boom extend, boom down, and winch up) are cut in order to prevent damage to the crane and the endangerment of persons near the lifting area.

Two-Block Warning

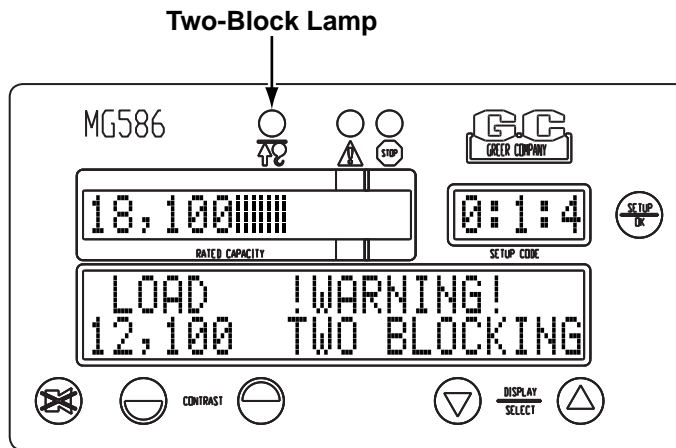

If the hook block is on a collision course with the head machinery at the end of the boom, the two-block lamp will illuminate and an audible alarm will sound continuously. The message: “!WARNING! TWO BLOCKING” will appear in the information window.

Crane motions [boom extend, boom down, and winch up] are cut in order to prevent damage to the crane and the endangerment of persons near the lifting area.

Alarm Override

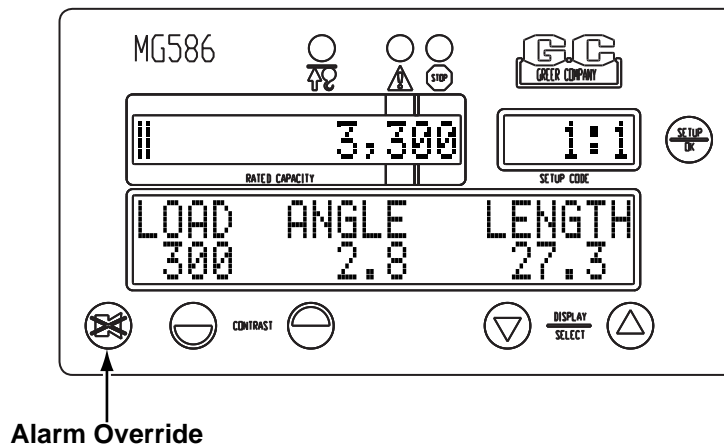

The alarm override button is used to temporarily disable current audible alarm conditions and to disable the automatic motion cutout. The audible alarm will sound again following any subsequent overload or two-block conditions, or any other alarm conditions.

To disable the audible alarm, press the **ALARM OVERRIDE** key. Continue to hold the button down for five (5) seconds to cancel any existing motion cuts. The **ALARM OVERRIDE** key must be held down to continue overriding the motion cut.

⚠ WARNING

THE ALARM OVERRIDE BUTTON SHOULD BE USED WITH CAUTION. AUTOMATIC AUDIBLE ALARMS WARNING AGAINST OVERLOAD, TWO-BLOCK DANGERS, AND HAZARDOUS TIPPING CONDITIONS ARE TEMPORARILY SILENCED WHEN THIS OPTION IS ACTIVATED. MOTION CUTOUT MAY ALSO BE DISCONTINUED.

Adjusting the Contrast

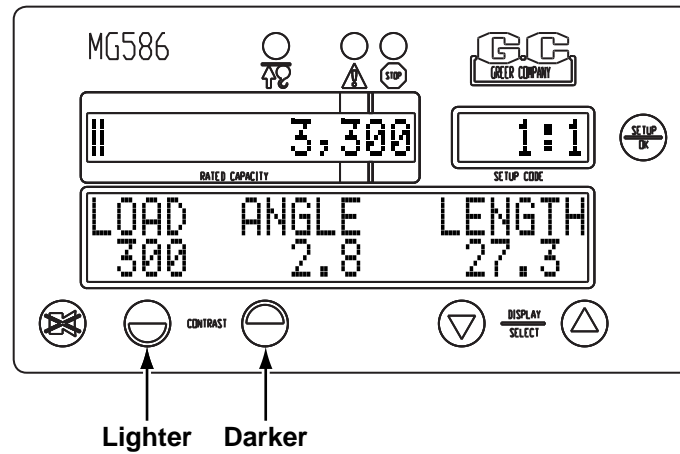

Changes in temperature and lighting conditions may require adjustment of the display contrast. Use the **CONTRAST** keys to lighten or darken the display as required.

System Calibration

Why Calibrate the System?

The system is pre-calibrated at the factory to set the extension and angle sensors at zero. However, the settings for length and angle are left blank because these must be entered on the crane to ensure accuracy.

In order for the computer to accurately measure the length and angle of the boom, we must enter accurate start and stop points for it to measure from and to. To accomplish this, the system is equipped with a calibration routine that operates through the system display console. The calibration procedure provides a means of ensuring that the sensors, cables, and hydraulic connection are correctly installed, positioned, and adjusted following system installation or parts replacement.

It is important that each step of this procedure is properly followed for the system to accurately provide load, rated capacity, warnings, and kick-out functions.

⚠ WARNING

AT ALL TIMES, OBSERVE SAFE PRACTICES. MAKE SURE THAT CRANE CAPACITY LIMITATIONS ARE UNDERSTOOD, AND THAT THE CRANE CAPACITY PLATE IS FOLLOWED. DO NOT EXCEED MANUFACTURER'S SPECIFIED LIFTING LIMITATIONS.

Required Tools

- 1/4" nut driver or T15 Torx driver
- Digital or bubble level calibrated and accurate to 0.1° at level
- 100" measuring tape - fiber type graduated in tenths of feet

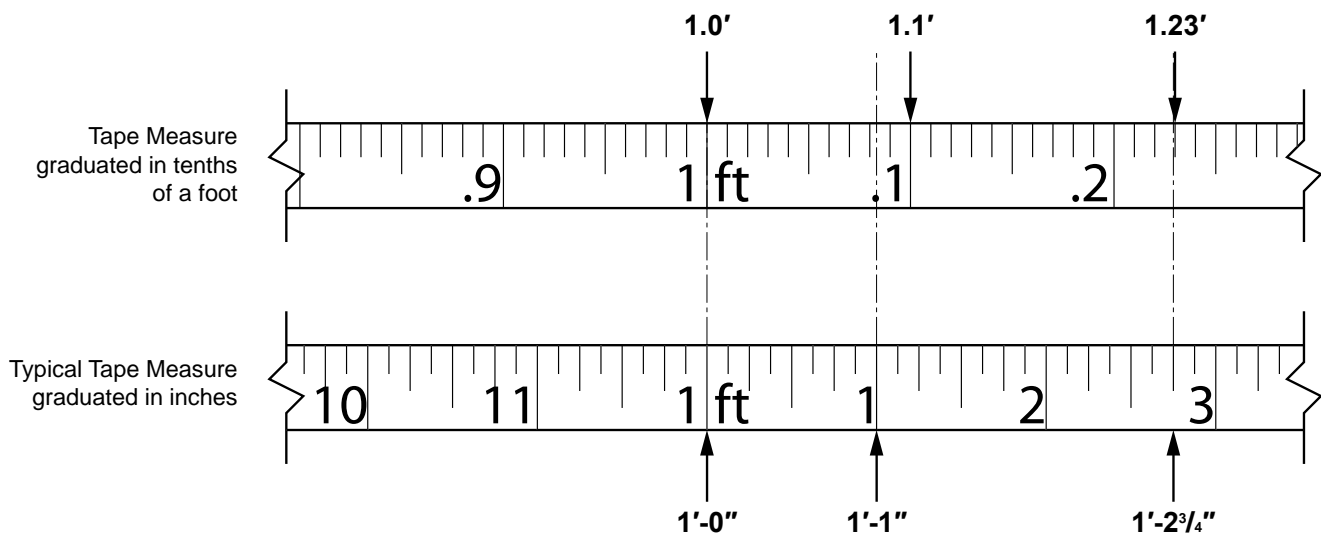

Note: The computer calculates measurements in feet and tenths of a foot, so having the correct measure will facilitate entering measurements.

- Digital volt/Ohm Meter capable of measurements to three decimal places

Note: When the installation is complete and all wiring is in place a voltage check should be performed to ensure the system is in proper working order. Refer to "Extension Reel Voltage Check" on page A-4.

Adjusting the Sensors

1. Position the crane on firm and level ground with the outriggers properly extended and set.
1. Fully retract the boom.
1. Position the level on the boom and adjust the boom until the level reads 0°.
1. Remove the cover from the extension reel to expose the extension and angle sensors.

Extension Cable Guides

Cable guides must be used to achieve proper placement of the first roller guide.

Cable guides maintain the position of the cable, ensuring a controlled path to the boom head.

The distance between the first cable guide and the center point of the extension reel must be a minimum of four (4) feet.

The inside edge of the first cable guide must always align with the outside edge of the extension reel.

Passage of the cable from the extension reel through the cable guides to the tie-off post on the boom head may form a straight line parallel to the boom, as shown, or may curve toward the boom depending on the placement of the cable guides in the latter segments of the crane.

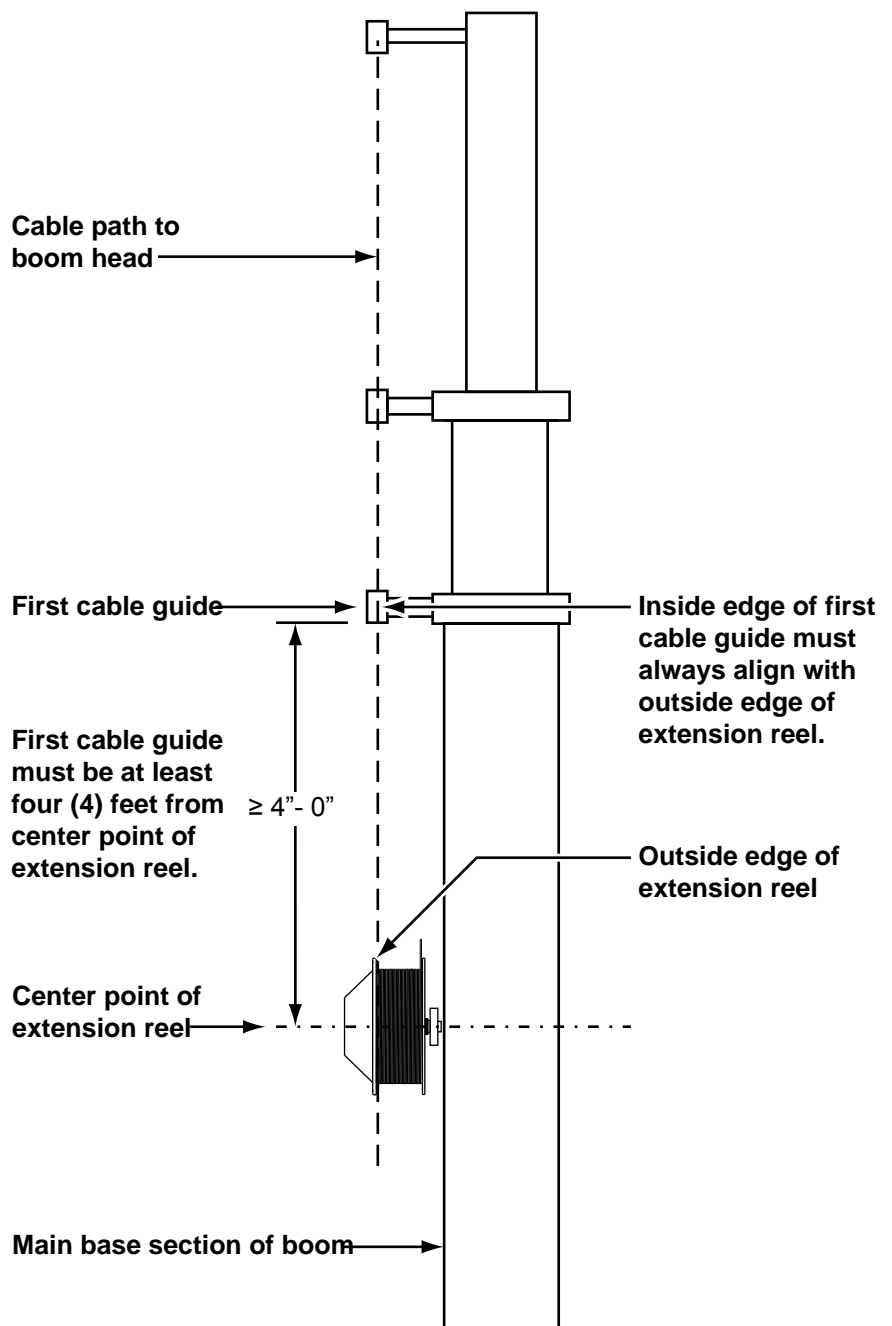

Installing the Reel-Off Cable

IMPORTANT!

THE REEL-OFF CABLE MUST BE PROPERLY PRE-TENSIONED. THIS PROCEDURE KEEPS THE CABLE TAUT AT ALL TIMES, WITH CONTROLLED, STEADY EXIT FROM THE EXTENSION REEL.

Follow the steps below:

Pre-Tension Steps

1. Fully retract the boom.
2. Slowly rotate the Extension Reel clockwise until a “click” is heard, indicating that the clutch inside the Reel is engaged.
3. Turn the Extension Reel counterclockwise for five (5) complete rotations.

Note: A temporary marker placed on the Extension Reel can facilitate the rotation count.

Pre-Tension is complete.

Adjusting the Extension Sensor

1. With the level on the boom reading 0°, rotate the extension sensor arm outward to disengage the gear.

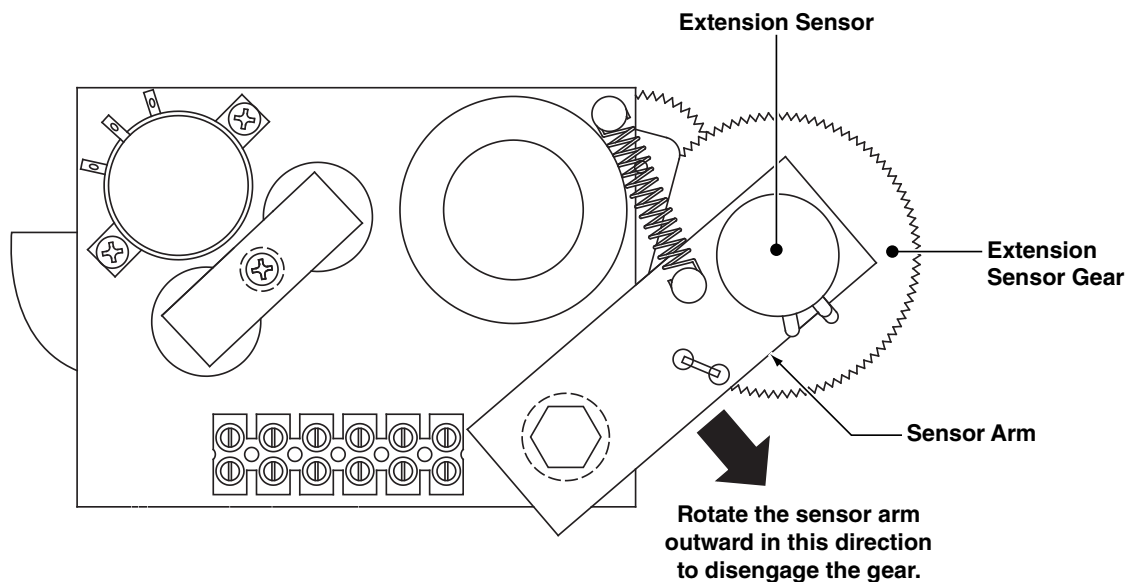

2. Rotate the extension sensor clockwise until the end of the pot is reached. Then, continue to rotate [applying more force] to cause the clutch to slip (this is usually identified by a click).
3. Rotate the sensor exactly 1/2 turn counter-clockwise to establish a proper voltage signal. Refer to “Extension Reel Voltage Check” on page A-4.
4. With the boom still level, measure the voltage of the angle sensor, refer to “Extension Reel Voltage Check” on page A-4.

Note: This check should be performed on older model cranes in the event the sensor has been removed and reinstalled, or repositioned incorrectly.

System Self-Test

System Self-Test

When the system is turned on, it goes through a brief self-testing process.

All three alarm indicators will light up, all display windows will appear black, and the audible alarm will sound.

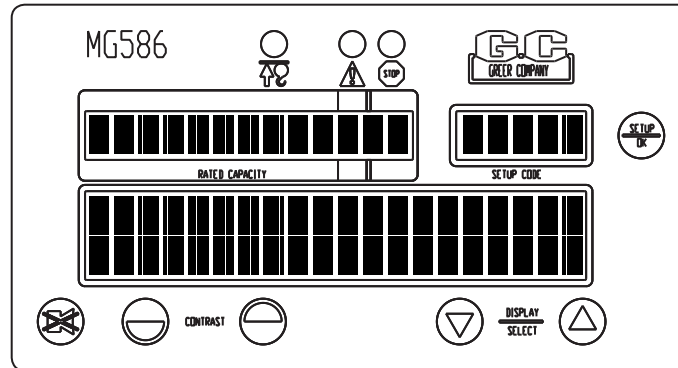

The information display will then show the crane model and capacity chart number for the system configured.

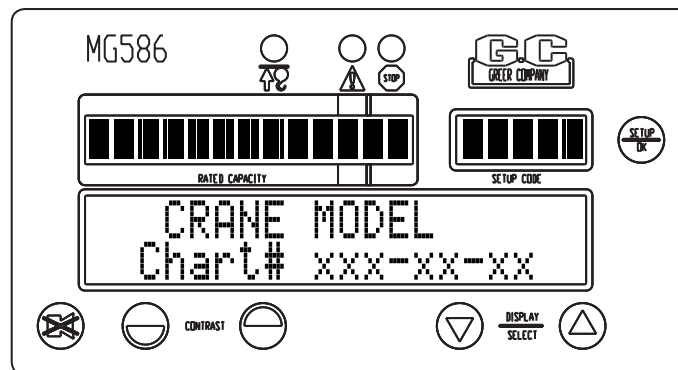

Following self-test, the system will go into the setup mode. The setup code window will display the same setup code used when the system was last powered off. Check that the correct setup code is displayed before operating the crane. Refer to "Configuration Selection" on page 7 for code setup instructions.

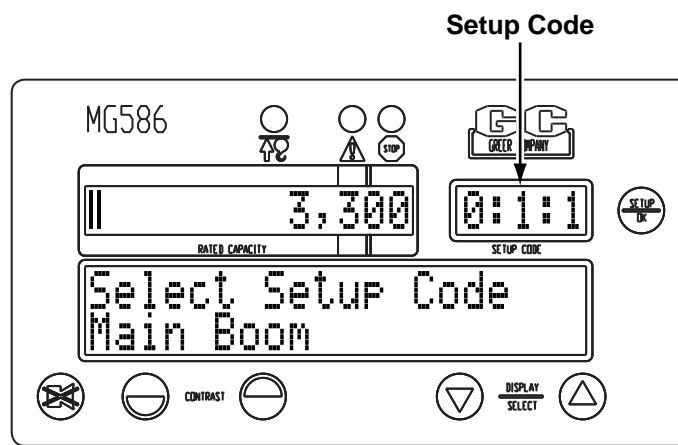

Configuration Selection

Configuration selection is required upon system power up; however, it can also be entered anytime by pressing the **SETUP** key.

The first stage allows selection of the stowed jib code.

Note: If no stowed jib options are available, this selection option is skipped.

The current stowed jib code will be flashing and the jib description is displayed in the information window.

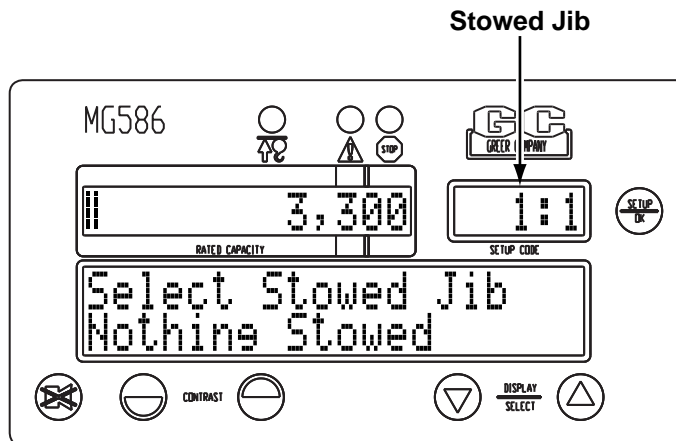

To select a different stowed jib, press the **UP ARROW** or **DOWN ARROW** key to display the desired option and press the **SETUP/OK** key to continue.

The current number of parts-of-line is now flashing.

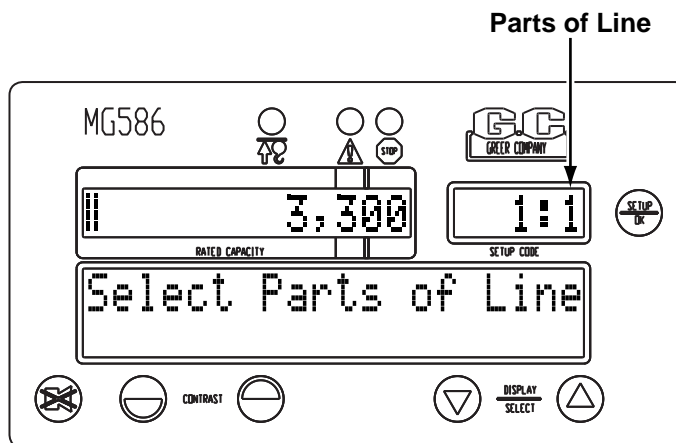

To change the parts-of-line, press the **UP ARROW** or **DOWN ARROW** key to select the desired number and press the **SETUP/OK** key to continue.

Note: Some configurations allow only single part-of-line operation. In these cases, the whole parts-of-line selection phase will be skipped and the parts-of-line will be set to 1.

Once the correct parts-of-line are entered, the system will exit the configuration mode and return to the normal working screen.

Entering Setup Mode

The display will guide you through each setup operation. During the setup procedure, the display console should be placed in a position that allows for easy viewing and operation while adjustments are being made within the boom extension reel.

The setup mode is activated by the following procedure:

1. Press and hold the **SETUP** and **UP ARROW** keys on the display for five [5] seconds

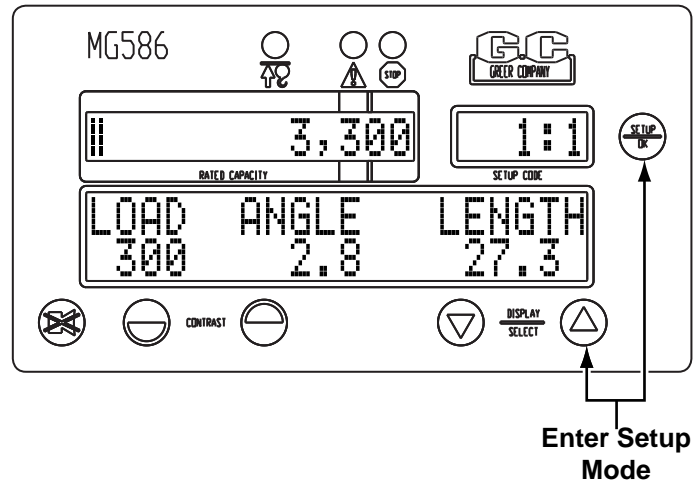

2. A brief self-test will take place.
3. Release the keys.

Boom Angle System Zero

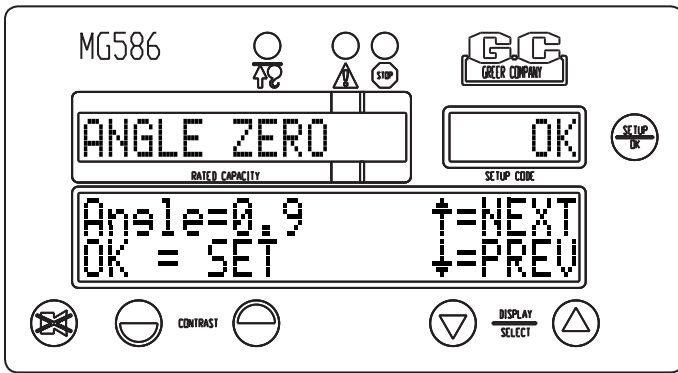

When the system enters calibration mode, the display will appear as in the illustration (angle reading may be different). Check to make sure the level on the boom is still at exactly zero degrees.

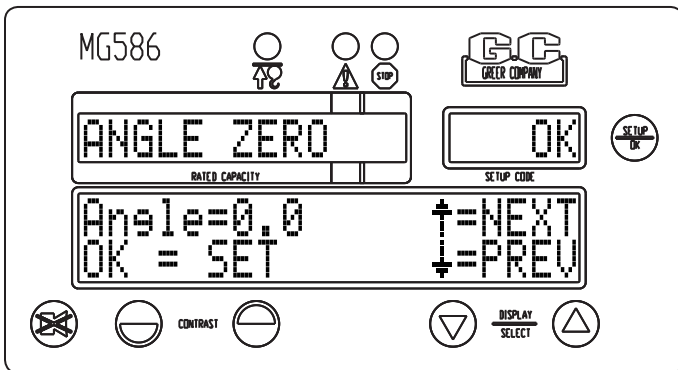

Press the **SETUP/OK** key to zero the system.

Press the **UP ARROW** key to continue.

Boom Extension System Zero

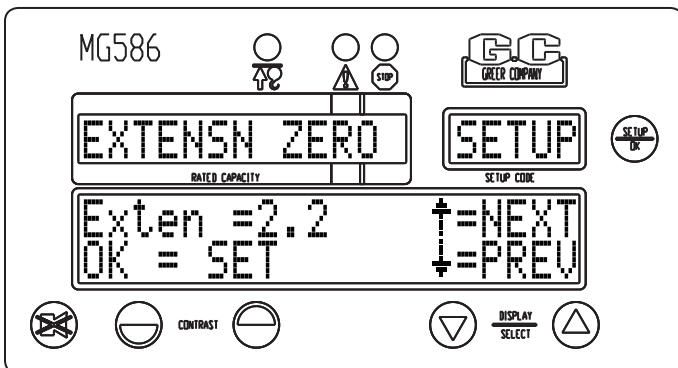

The display will appear as in the illustration (extension reading may be different). The extension sensor must be set to zero according to the procedure described previously.

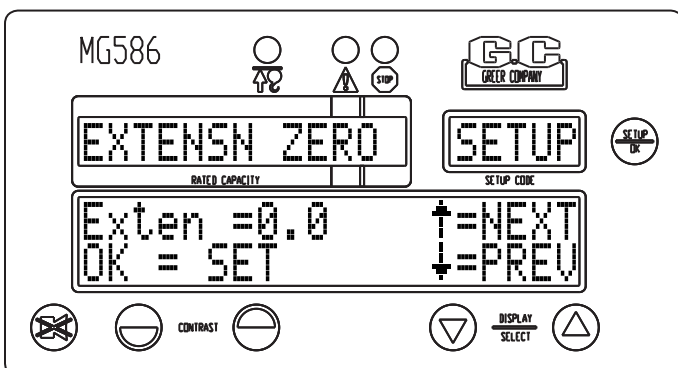

Press the **SETUP/OK** key to zero the span.

Press the **UP ARROW** key to continue.

Angle Span System Set

Raise the boom to exactly 60 degrees as read from the level.

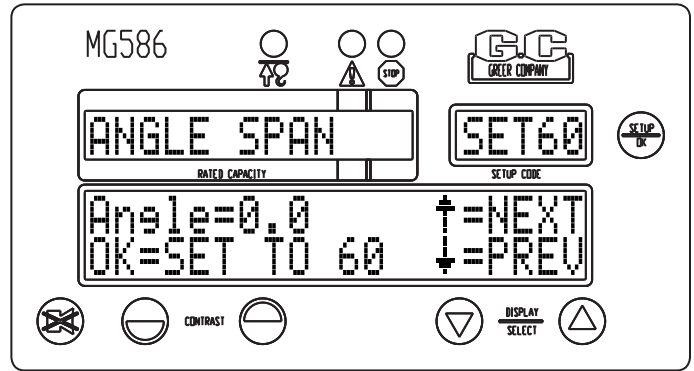

Press the **SETUP/OK** key to set the system to 60 degrees.

Press the **UP ARROW** key to continue.

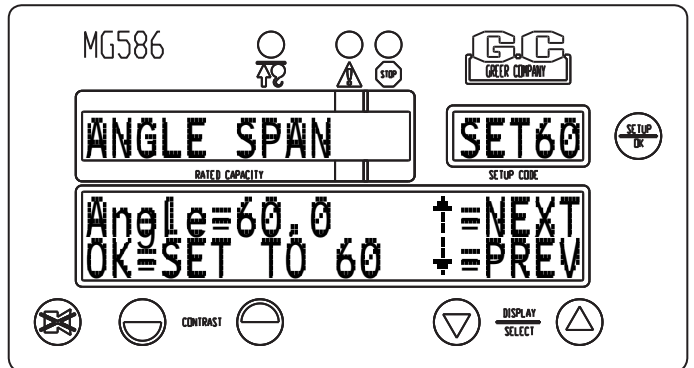

Boom Length Trim

With the boom still elevated at 60 degrees, fully extend the boom to the end of the stroke of the extension cylinder (as indicated by a clunking sound).

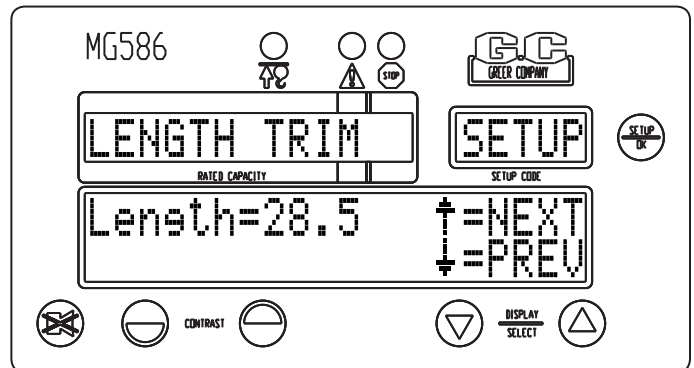

As the boom reached full extension, the text "OK=TRIM" will appear in the information window under the text "Length =xx.x".

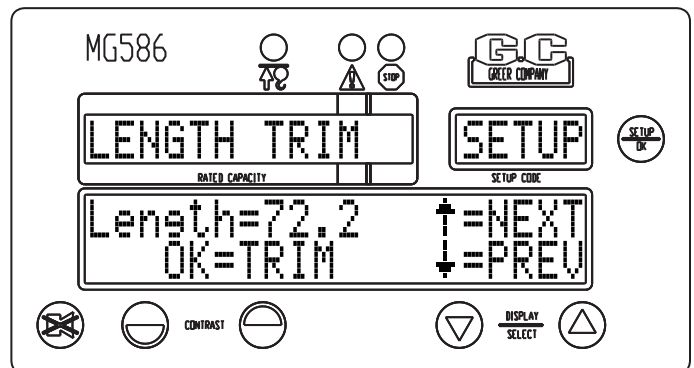

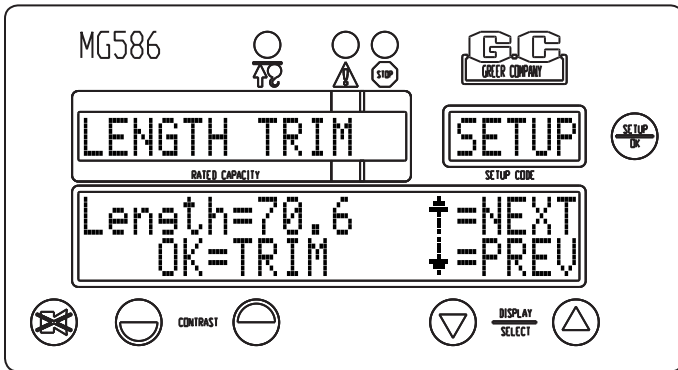

Press the **SETUP/OK** button to trim the length. The length measurement will be set to the exact length of the span and the extension number will be spanned in the computer calibration.

Press the **UP ARROW** key to continue.

Viewing Rope and Cable Limits

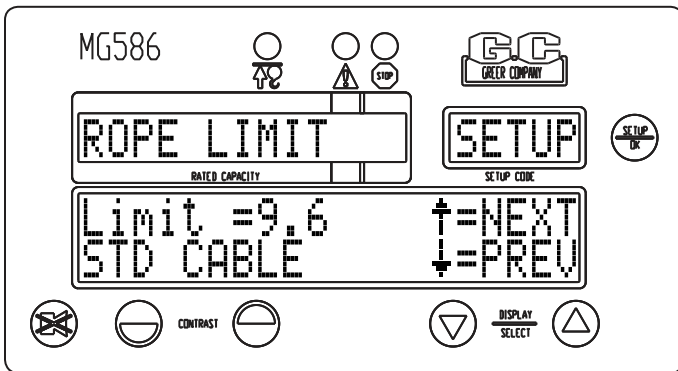

The system will display the proper cable limits for the type of cable selected. The cable types are preset from the crane configuration chart.

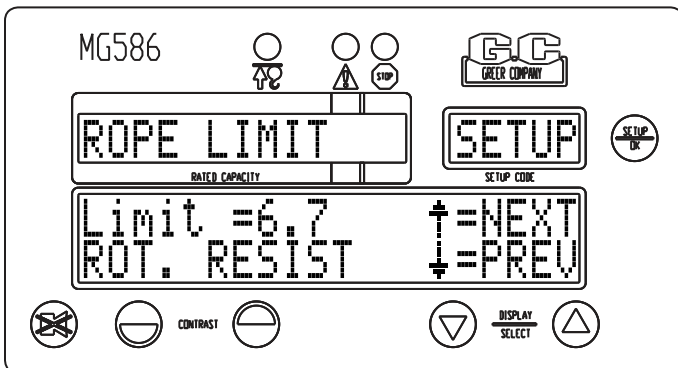

Press the **SETUP/OK** button to toggle between the types of cable.

Press the **UP ARROW** key to continue.

Jib Selection Setup (Interlock)

The displayed selection text differs for each model of crane; therefore, the displayed text may not exactly match the text in the images below.

1. Press the **SETUP** key to activate the jib selection mode. Current jib selection text will flash or blink on the display.

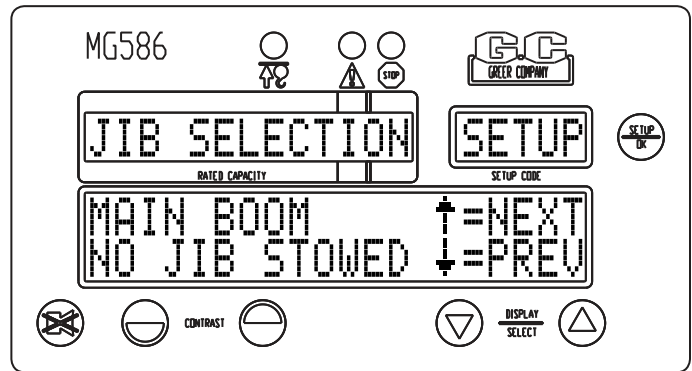

2. Use the **UP ARROW** and **DOWN ARROW** keys to scroll through the available jib selections. Stop at the desired jib selection.
3. Press the **SETUP** key to select and lock in the new jib selection. As soon as the selection is locked in, the selection text will stop flashing.

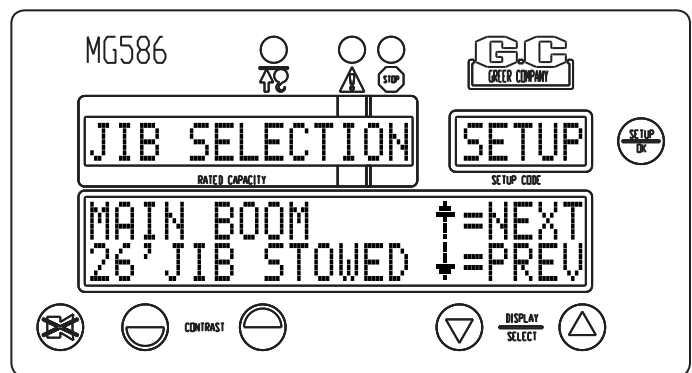

4. With the jib selected, setup is complete and you are returned to the information screen.
5. Replace the boom extension reel cover, ensuring that all 12 screws are fitted and evenly tightened.

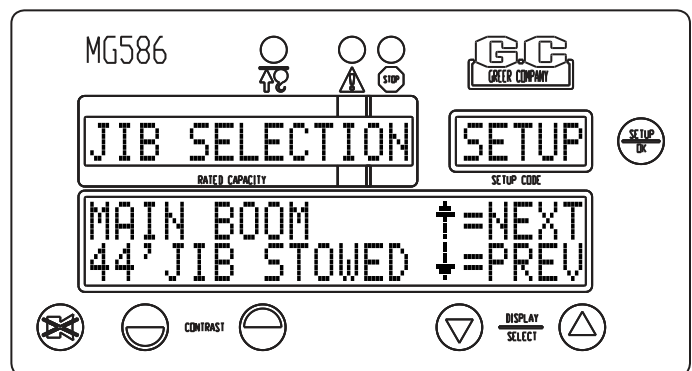

System Maintenance

It is recommended that the following checks be performed on the system prior to each shift or crane operation to help prevent errors or malfunctions:

Crane configuration and system setup

The crane configuration defines the physical setup of the crane. The system setup defines the load parameters for each configuration. The data for these calculations are loaded in the capacity chart and installed in the crane's computer prior to factory shipment.

IMPORTANT!

ENSURE THAT THE CONFIGURATION CODE NUMBER IN THE DISPLAY CONSOLE WINDOW IDENTIFIES THE CRANE'S CONFIGURATION FOR THE CURRENT OPERATION. IF IN DOUBT, SELECT THE CODE NUMBER AGAIN FOLLOWING THE STEPS OUTLINED IN THE SECTION ON CRANE OPTIONS AND SETUP CODES.

Extension reel, Reel-off cable to boom tip, extension reel cable to computer

The extension reel houses the reel-off cable to the boom tip, a cable from the extension reel to the computer, and the boom angle sensor. The extension reel provides the following signals that are sent directly to the computer via the extension reel computer cable:

- The **boom extension signal** is generated within the extension reel, and controlled by the reel-off cable, as the boom is extended or retracted. The extension reel measures the boom extension and provides a signal, which enables the computer to calculate the operating radius of the crane, the weight of the actual load, and the percent of rated capacity.
- The **two-block signal** is transmitted from the boom head, through the reel-off cable, to the extension reel and the extension reel cable to the computer. This signal becomes active when the anti-two-block switch opens, indicating a two-block condition. When this signal reaches the computer, it causes an immediate display of a flashing light and an audible alarm on the operator's display console, and the motion cutouts are activated.
- The **boom angle signal** is generated within the extension reel, and designed to measure the angle of the boom relative to the horizon.
- The **reel-off cable** (extension cable) extends from the extension reel to the boom tip. The reel-off cable provides an electrical path for passage of the two-block warning signal from the boom tip to the computer cable in the extension reel. Check the following:
 - Carefully examine the reel-off cable for damage.
 - Fully telescope the boom in and out. As you extend or retract the boom, ensure that the reel-off cable is smoothly fed on and off the extension reel without drooping along the boom or jumping, especially as the boom is retracted.

⚠WARNING

THE EXTENSION REEL EXTENSION SETTING IS FACTORY PRESET. IF THE REEL-OFF CABLE HAS BEEN BROKEN, CALL YOUR SERVICE REPRESENTATIVE. DO NOT ATTEMPT TO REPAIR A BREAK IN THE REEL-OFF CABLE WITHOUT CONSULTING WITH YOUR SERVICE REPRESENTATIVE.

Hydraulic connections

The two hydraulic pressure sensors, mounted in the computer, measure the pressure within each side of the boom hoist cylinder. The pressure sensors are connected to the boom hoist cylinder valve block by two flexible hoses. Both hoses are subject to the full hydraulic pressure contained within the upper and lower sides of the boom hoist cylinder.

- Ensure that there are no hydraulic leaks at either connection end of both hoses. Check for signs of wear or damage along the length of each hose.

Anti-two-block weight

- Ensure that the anti-two-block weight and its parts are undamaged, in proper position, and correctly connected.
- Check the chain on the anti-two-block weight for damage and stress, ensuring that there are no open links in the chain.
- Ensure that the chain is securely attached with screw pin and shackle to the narrow vertical connector projecting from the base of the anti-two-block switch.
- Ensure that the anti-two-block weight has been installed around one part of the load line.

Anti-two-block switch

- Ensure that the anti-two-block switch is secure on its mounting post with safety pin inserted through the end of the mounting post and locked into position.
- Ensure that the switch cable is secured to the strain relief thimble and that the thimble is on the mounting post behind the switch.
- Ensure that all electrical cables and connectors are free from damage and correctly connected. See anti-two-block switch installation.

Checking the two-block warning signals and cutout of machine motions

The following test activates the anti-two-block warning signals and the valve controlling cut out of crane motions to ensure proper operation. No other pre-existing alarm conditions may be active when performing this test.

⚠WARNING

BEFORE PERFORMING THIS TEST, TURN THE CRANE POWER OFF AND THEN ON AGAIN TO ENSURE THAT AN EXISTING TWO-BLOCK WARNING AND/OR MOTION CUT HAS NOT BEEN OVERRIDDEN.

DURING THIS TEST, DO NOT PRESS THE ALARM OVERRIDE KEY TO DISABLE THE AUDIBLE ALARM.

DURING THIS TEST, DO NOT WINCH THE HOOK BLOCK INTO THE BOOM TIP, IN CASE THE SYSTEM DOES NOT CUT THE CRANE MOTIONS.

1. Slowly raise the hook block until it lifts the anti-two-block weight and deactivates the anti-two-block switch.

NOTE: This action should cut out the winch up motion as well as the boom down, and boom extend motions. Audible and visual alarms on the operator's display console should become active.

2. Lower the hook block by winching down.

NOTE: This action should disable the audible and visual alarms on the operator's display console and activate the boom motions.

Computer Cable

The extension reel cable to the computer acts as a channel for passage of signals to the system computer.

- Ensure that the cable exiting from the extension reel and running down the boom and around its pivot to the computer is free from damage. If this cable has been damaged in any way, it should be carefully tested and may need to be replaced to ensure accurate transmission of signals.

Load Test

The best way to identify a possible problem in the system is to do a load test. The accuracy of the load test is dependent upon accurate operation of all of the sensors in the system and the correct code number setting for the configuration of the crane. If no stowed deduct configuration is provided by the system, perform this test with stowed attachments removed.

It is recommended that a load test be performed monthly.

⚠WARNING

ENSURE THAT THE CONFIGURATION CODE NUMBER IN THE DISPLAY CONSOLE WINDOW IDENTIFIES THE CRANE CONFIGURATION FOR THE CURRENT OPERATION. IF IN DOUBT, SELECT THE CODE NUMBER AGAIN FOLLOWING THE STEPS OUTLINED IN THE CRANE OPTIONS AND SETUP CODES.

Load Test Steps

1. Select a known weight of at least 20% of maximum rated capacity.
2. Calculate the weight of the total load, including the slings and hook block.
3. Lift the weight, and record the load weight displayed on the display console. The load weight on the console should be between 0 to 10% higher than the load that was lifted. EXAMPLE: When lifting 5000 lbs., the display console window should read between 5000 and 5500 lbs.

⚠WARNING

A LOAD READING ON THE DISPLAY CONSOLE THAT FALLS OUTSIDE OF A 10% RANGE MAY INDICATE A SENSOR PROBLEM. CALL YOUR SERVICE REPRESENTATIVE.

Appendix A - Troubleshooting

System Fault Messages

When the system detects a fault, the red warning lamp will illuminate and the message, "WARNING: SYSTEM FAULT" will flash on the display. When a more serious fault is detected, the message, "WARNING: SYSTEM OUT OF SERVICE" will flash.

To determine the fault, press the **UP ARROW** or **DOWN ARROW** key once or twice. The information window will display the related fault message. This message will appear for up to 20 seconds before the display returns to its normal display mode. If the **UP ARROW** or **DOWN ARROW** key is pressed before the 20 seconds have elapsed, the display will automatically return to its normal display mode.

Fault messages that can appear on the display and the required corrective action follow:

Fault Message	Corrective Action
Reselect Crane Setup	This message indicates that there is an error in the crane setup selection, or there is an internal computer fault. Reselect the correct crane setup code; the error should correct itself. If not, replace the computer. Refer to "Computer Replacement" on page A-3.
Check Extension	This message indicates a problem with the boom extension sensor. <ol style="list-style-type: none">1. Inspect/check cabling and connections from computer to extension reel on the side of the boom.2. Inspect/check the extension reel-off cable for damage.3. Refer to "Boom Angle System Zero" on page 18 and "Boom Length Trim" on page 19.4. Remove the extension reel cover to verify operation of the extension reel. Refer to "Extension Reel Voltage Checks" on page A-4.
Check Angle	This message indicates a problem with the boom angle sensor. <ol style="list-style-type: none">1. Inspect/check cabling and connections from computer to extension reel on the side of the boom.2. Refer to "Boom Angle System Zero" on page 18.3. Remove the extension reel cover to verify operation of the extension reel. Refer to "Extension Reel Voltage Checks" on page A-4.

Fault Message	Corrective Action
Check ATB Wiring	<p>This message indicates an anti two-block wiring problem usually due to an electrical short to the boom or a damaged cable.</p> <ol style="list-style-type: none"> 1. Inspect/check cabling and connections from computer to extension reel on the side of the boom. 2. Inspect/check reel-off cable from extension reel to boom tip and Anti Two-Block switch connections. 3. Verify electrical signals for the two-block drive and signal within the extension reel. Refer to "Extension Reel Voltage Checks" on page A-4.
Check FKO	<p>This message indicates a Function Kick-Out wiring problem that is usually caused by a fuse or crane circuit breaker failure. Remove the computer unit lid and check the 10A fuse.</p>
Replace System Chip	<p>This message indicates a problem with the system chip fitted inside the computer.</p> <ol style="list-style-type: none"> 1. Remove the computer lid and replace the system chip. <p>Note: Use only proper chip insertion and removal tools to perform this operation. Never use a screwdriver.</p>
Replace the Computer	<p>This message indicates an internal fault in the computer. In some cases, it may not be necessary to replace the computer unit.</p> <ol style="list-style-type: none"> 1. Remove the computer unit lid and check the Internal LED status indicators located on the computer circuit board. 2. Refer to "Computer Internal Status Indicators" on page B-1.

Computer Replacement

To remove the computer unit:

1. Place the boom in its rest.
2. Turn off electrical power.
3. Disconnect all electrical connectors from/to the computer.
4. Disconnect hydraulic hose connections from/to the computer.
5. Remove computer from mounting.

⚠WARNING

THE HYDRAULIC HOSES CONNECT DIRECTLY TO THE BOOM HOIST CYLINDER. DO NOT OPERATE THE CRANE UNLESS THE COMPUTER HAS BEEN PROPERLY REPLACED OR THE HYDRAULIC CONNECTIONS ARE PROPERLY CAPPED.

To install a new computer unit:

1. Mount the computer unit.
2. Ensure that a new system chip has been supplied with the computer.
Note: Do not use the system chip from the original computer unit.
3. Ensure that all electrical power is turned off.
4. Connect all electrical connectors to the computer unit.
5. Connect hydraulic hoses to the computer pressure ports. (Green is base-side and red is rod-side of the boom hoist cylinder.)
6. Follow the system setup instructions in this manual.

Note: If more than one fault is present, the most serious fault will appear first and must be resolved first. When the first fault is corrected, other existing faults will be displayed and must be resolved one at a time until no further fault codes are listed.

Fault messages should be reported to the service representative along with any noticeable damage done during system installation or routine checks. Please refer to routine checks and maintenance in this manual.

Extension Reel Voltage Checks

If problems occur with the two-block alarm operation, angle, or extension sensor, the following chart details voltage checks that may be made within the extension reel. Follow the action column before measuring voltages at the specified points in the voltmeter connection columns. Measure all voltages with a digital voltmeter set to DC volts range.

SIGNAL	BOOM POSITION/ ACTION	VOLTAGE		VOLTMETER CONNECTION	
		MIN	MAX	RED (+)	BLACK (-)
SENSOR DRIVE	-	+4.7V	+5.3V	TB1/4 - RED	TB1/1 - BLUE
ANGLE SEN- SOR OUTPUT	0 degrees	0.4V	0.6V	TB1/2 - GREEN	TB1/1 - BLUE
EXTENSION SENSOR OUT- PUT	0 ft. (0m) FULL RETRACTED	0.15V	0.35V	TB1/3 - WHITE	TB1/1 - BLUE
TWO-BLOCK DRIVE	A2B WEIGHT DOWN	5.5V	7.5V	TB1/6 - BLACK	TB1/1 - BLUE
	A2B WEIGHT UP	9.5V	10.5V	TB1/6 - BLACK	TB1/1 - BLUE
TWI-BLOCK SIGNAL	A2B WEIGHT DOWN	5.5V	7.5V	TB1/5 - BROWN	TB1/1 - BLUE
	A2B WEIGHT UP	0V	2V	TB1/5 - BROWN	TB1/1 - BLUE

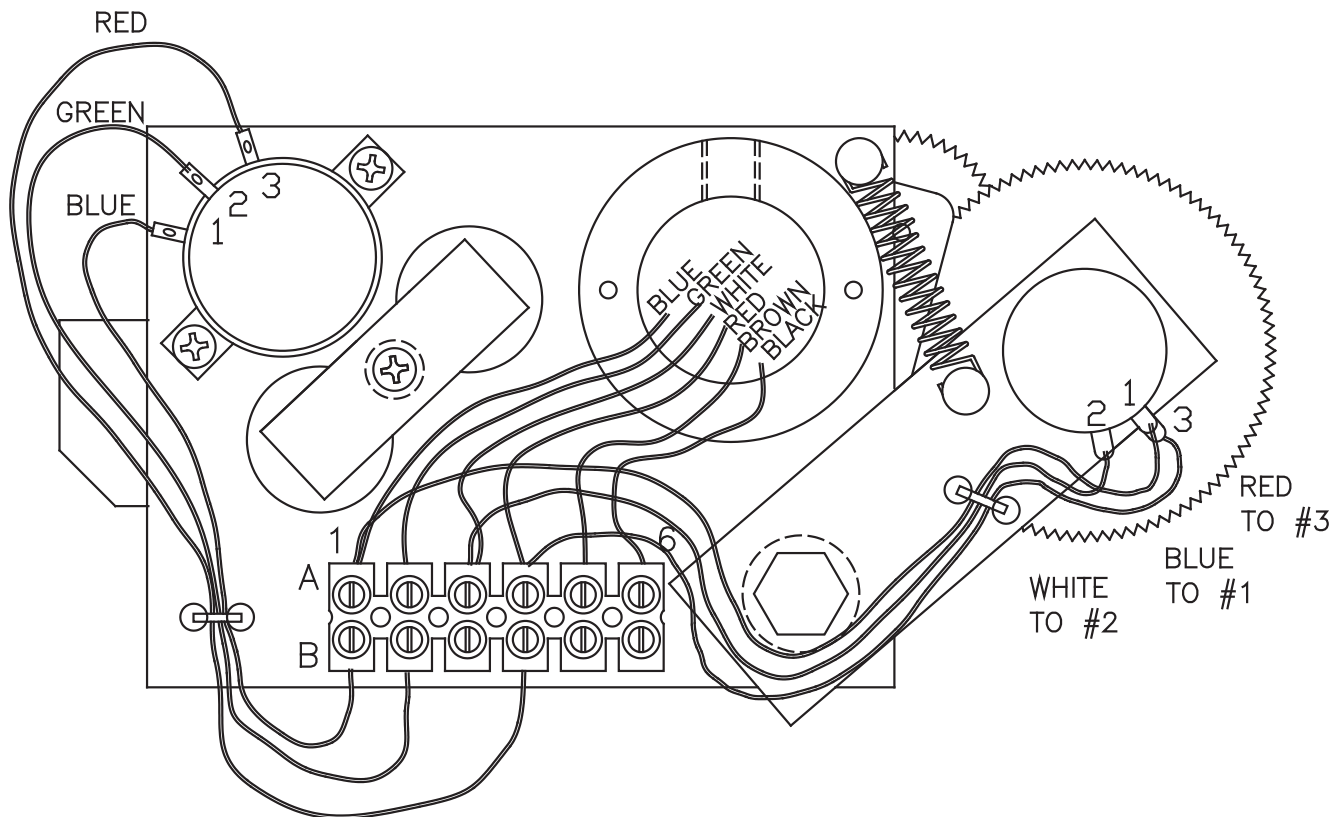

Notes:

Angle sensor output is set to 10% [1/10th] of sensor drive voltage with boom at zero degrees.

Extension sensor is set to 5% [1/20th] of sensor drive voltage with boom fully retracted.

Appendix B - Computer Troubleshooting

Computer Internal Status Indicators

The computer unit contains six LED indicators that provide an aid to checking presence of power supply voltages and communications between the computer and display console. There are five power indicators (D2 through D6) and one communications indicator (D7), all Indicators are bright green light emitting diodes.

With the exception of the communications indicator, all indicators should be illuminated at the same brightness level with the system power on. A missing or dimly lit indicator indicates a power supply problem.

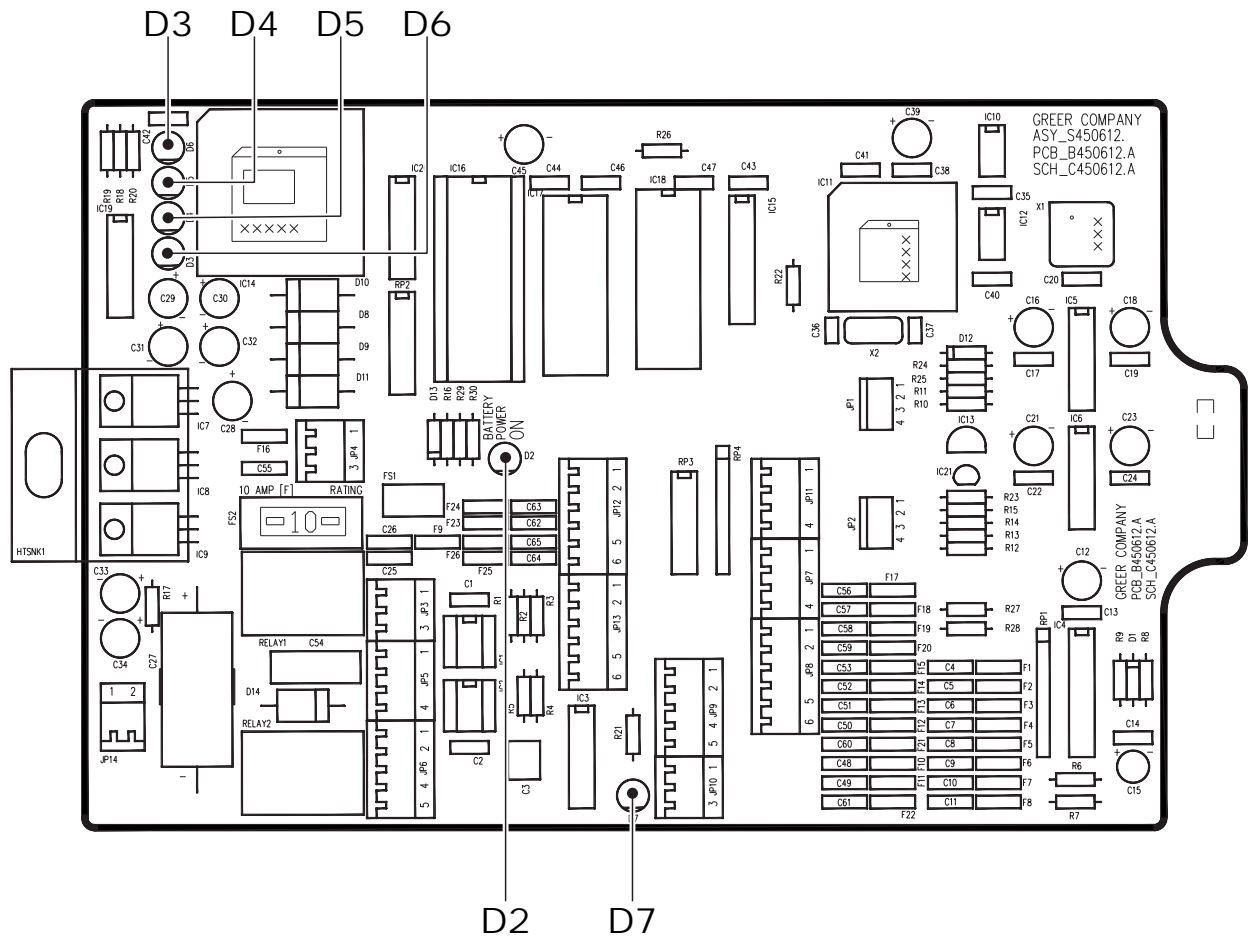

LED Indicator	Function
D2	Battery Power
D3	+5V Analog Poser
D4	+5V Digital Power
D5	+10V Relay Drive Power
D6	Protected Machine Power
D7	Communication Indicator

Power Indicator States and Actions

Power Indicator State	Corrective Action
All indicators OFF	Check power and ensure that PTO switch is properly engaged.
D2 ON but all other indicators OFF	Check display console cable and connection.
D5 OFF but all other indicators ON	Replace computer
D3, D4 and D7 OFF but all other indicators ON	Replace computer
D3 OFF but all other indicators ON	Check extension reel signal cable and internal voltages within extension reel.

Communication Indicator

The Communication Indicator provides an indication of the success or otherwise of communication with the display console, and of the running state of the computer program.

Carefully observe the Communication indicator and the display console at power on and through self-test, and then use the following chart to help decide the course of action.

Communication Indicator Indications At Power On	ACTION
From the moment the system power is applied, the COMM indicator does not illuminate. During and after the self-test period of eight seconds, the COMM indicator remains off.	The computer is not running. Check status indicators (D2 through D6). Try to reset the system by powering off and on again. Listen to the computer for the relays to click. If they do not click, replace the System Chip If not successful, replace the computer. If the relays do click, replace Communication chips IC1, and IC2.
From the moment the system power is applied, the COMM indicator does not illuminate. The display console, which never goes to normal, continually reads: "No Communication with MicroGuard."	Communication with the display has not been made. Is the display console connected? Check connector and cabling to the display console.
At the moment power is applied, the COMM indicator flashes briefly, then switches off. After a few seconds, the COMM indicator starts to flash at a fast rate and never stops.	This is the normal operation of the communication between the computer and display console.

Start-up Problems

Condition	Corrective Action
Display unit lights and alarms are flashing; the computer unit sounds as if it is buzzing.	<ul style="list-style-type: none"> • Make sure the PTO is fully engaged.
During system setup, it is not possible to adjust the angle sensor. The display shows "---".	<ul style="list-style-type: none"> • Make sure the extension reel is installed the correct way up. • Make sure the extension reel signal cable is correctly connected to the computer unit. • Check the extension reel voltages. Refer to "Extension Reel Voltage Checks" on page A-4.
A few seconds after power up, the display shows "No communications with MicroGuard®" in the load display window.	<ul style="list-style-type: none"> • Computer is possibly not running. • Check that the system program chip is correctly inserted. • Check that all LEDs within the computer are lit and that the communications LED (D6) is flashing; If not replace system chip. • Check the display cable for damage.

Appendix C – Error Codes

Grouped Error Codes

The MicroGuard® 586 display used in conjunction with the MicroGuard® 500R computer has the capability of producing grouped error codes for use as a troubleshooting tool and guide. The error codes assist in pinpointing problem areas.

When an error is detected, the information window will display the message “SYSTEM OUT OF SERVICE”.

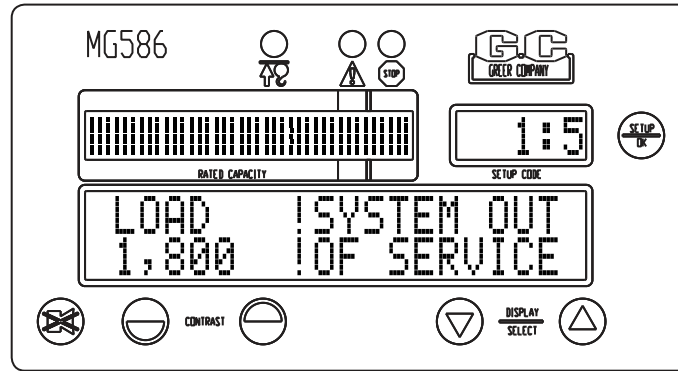

Press the **UP ARROW** KEY to display the specific problem.

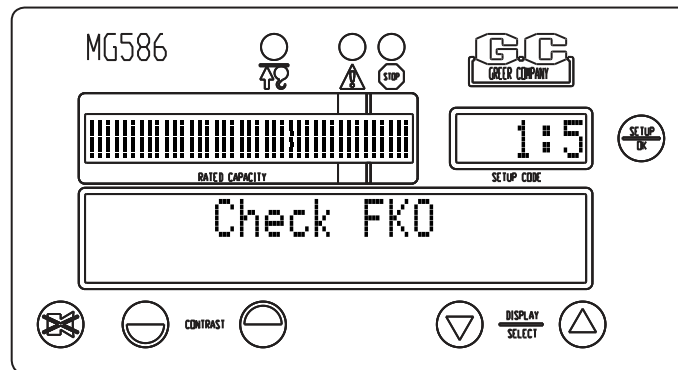

Most of the time an error can be located and defined by using the general definition. However, a more detailed code definition may be required for diagnosis.

Press the **SETUP** key on the display.

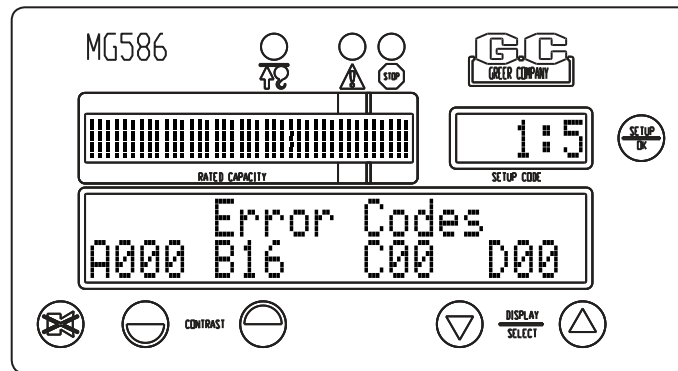

The codes will appear on the screen by group with a code number to define the specific fault. Refer to the repair manual for proper voltages and testing.

Group “A” Faults

General Definition: Group A is designed for all analog sensor inputs. These functions must operate within a specific range of output; if not within the expected range as called for in the program instructions, the computer will produce a fault code “A XXX.” When the fault code is compared to the error code chart, a specific sensor will be identified for checking.

Detailed Code Definition:

A1	TXO Piston Pressure Out of Range	The pressure transducer is a “non-adjustable” part. Replace Computer if no obvious faults found.
A2	TX1 Rod Pressure Out of Range	The pressure transducer is a “non-adjustable” part. Replace Computer if no obvious faults found.
A3	Extension Sensor out of Range	Adjust and Calibrate Extension Sensor.
A4	Angle Sensor Out of Range	Adjust and Calibrate Angle and Angle Span.

Group “B” Faults

General Definition: Group B monitors internal voltage feeds, such as the ATB Input/Output circuit, and transducer inputs.

Detailed Code Definition:

B1	ADC (Piston Pressure) Not Responding	Replace Computer– Not field repairable.
B2	ADC2 (Rod Pressure) Not Responding	Replace Computer– Not field repairable.
B8	Bad ATB Feed	Check out ATB Cable system for abnormalities or shorts.
B16	Bad FKO Feed	Check Circuit Breakers.

Group “C” Faults

General Definition: Group C monitors the computer memory modules. The only part of this group that would be user serviceable is the Executive Program Chip, which is changeable.

Detailed Code Definition:

C1	Bad Executive EPROM Checksum	Change Program Chip.
C2	Bad Duty ROM Checksum	Change Program Chip.
C4	Bad RAM Test	Change Computer.
C16	Bad Serial EEPROM Test	Replace Computer.

Group “D” Faults

General Definition: Group D refers to Load Chart (or Duty Chart) as it applies to specific sensor inputs. If one of the analog sensors is producing signals that are out of the specific voltage criteria, the computer will not be able to find a specific load chart to match this criteria. This code is usually accompanied by an analog or “A” code.

Specific Code Definition

D1	No Duty Found	Check out Analog Inputs and Calibration.
D2	No Duty Because of Bad Extension Match	Check out Analog Inputs and Calibration.



Consider Yourself Warned.™

1918 East Glenwood Place • Santa Ana, CA 92705-5108

Voice: 714-259-9702

Fax: 714-259-7626

800-346-5245

Greer Company is a part of Tulsa Winch Group.



www.team-twg.com

As a leader in product innovation, Greer Company is committed to the ongoing improvement of its equipment.

We reserve the right to make changes to our products without notice.

© 2007 Tulsa Winch Group. All rights reserved.

W458200 Rev. E 07/07