

To learn more about this model, call 414-764-9200 or visit giuffre.com today!

MANITEX ARTICULATING CRANE SOLUTIONS

LIFTING YOU TO EXCELLENCE



Manitex
Articulating Cranes



AVAILABLE AT:

GIUFFRE.COM

GIUFFRE BROS CRANES INC.

6635 SOUTH 13TH ST. - MILWAUKEE, WI 53221
414-764-9200 • 877-321-3710

To learn more about this model, call 414-764-9200 or visit giuffre.com today!

PRODUCT RANGE

The range of Manitex Articulating Cranes (MAC), from 1.5-tm to 210-tm, **covers all load handling needs.**



SMALL CRANES

Cranes with lifting capacity up to 3 tm, usually installed onto entry level trucks.

MAC 1.5 LA
MAC 2.5 LA
MAC 2.7
MAC 2.8
MAC 3 P
MAC 3.5 LA
MAC 3.6
MAC 3.9 SP



LIGHT CRANES

Cranes with lifting capacity up to 15.5 tm, usually installed onto trucks from 19,500 lbst GVW.

MAC 4
MAC 4.5
MAC 5 P
MAC 6
MAC 6.5 P
MAC 8
MAC 8.5 P
MAC 9
MAC 9.5 P
MAC 9.5 S
MAC 10.5 SP
MAC 11
MAC 11.5 P
MAC 12
MAC 12.5 S
MAC 12.5 SP
MAC 13 P
MAC 13.5 SP
MAC 15.5

To learn more about this model, call 414-764-9200 or visit giuffre.com today!

MEDIUM CRANES

Cranes with lifting capacity up to 40.5 tm, usually installed onto trucks from 33,000 lbs. GVW to 66,000 lbs GVW.



MAC 16.5 S	MAC 26.5 S
MAC 18 SP	MAC 27.5 S PX
MAC 19	MAC 28.5 SP
MAC 21	MAC 30.5 SP
MAC 21.5 S	MAC 32.5 S PX
MAC 23 P	MAC 36.5 S
MAC 23.5 SP	MAC 38.5 SP
MAC 24 PX	MAC 40.5 SP

HEAVY CRANES

Cranes with lifting capacity up to 85 tm, usually installed onto trucks from 66,000 lbs to 86,000 lbs GVW.



MAC 47.5 SP	MAC 57.5 SP
MAC 48.5 SP	MAC 58.5 SP
MAC 50 P	MAC 65 SP
MAC 53 SP	MAC 85 SP
MAC 57.5 PX	

SUPER HEAVY CRANES

Cranes with lifting capacity up to 210 tm, usually installed onto trucks from 76,000 lbs GVW.



MAC 100 SP
MAC 150 SP
MAC 210 SP

To learn more about this model, call 414-764-9200 or visit giuffre.com today!

IDENTIFY YOUR CRANE

PRODUCT NAMING MADE EASIER

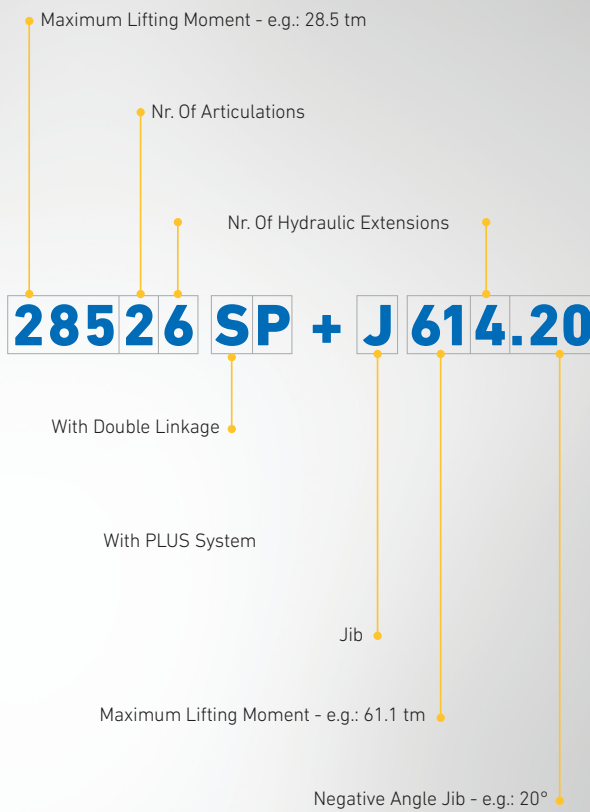

AVAILABLE AT:

GIUFFRE.COM

GIUFFRE BROS CRANES INC.

6635 SOUTH 13TH ST. - MILWAUKEE, WI 53221
414-764-9200 • 877-321-3710

CHOOSE YOUR CRANE

PRODUCT SERIES AND FEATURES THAT FIT YOUR NEEDS

MAC's crane classification makes it easier to choose the most appropriate model.

The six ranges rank MAC models depending on standard and optional equipment:

- CLASSIC SERIES**
- CLASSIC PLUS SERIES**
- SILVER SERIES**
- GOLD SERIES**
- PLATINUM SERIES**
- POWER LIFT**



Maximum lifting



Maximum horizontal hydraulic reach



Maximum vertical hydraulic reach



Slewing system



Standard crane weight



LC crane weight



Slewing by rack



Slewing by ring



Double linkage



Proportional hydraulic control valve block compensated



Multifunction radio remote control



Regenerative kit



Proportional control valve block



LPHV valve



4 m alarm sensor with control panel in cab



JIB Multipower function



Rotating hydraulic stabilizer



Winch



Hose reel



Hose track



Extension sequence boom



Available top seat or ground control



Remote-controlled outriggers and MCS system



Available LC version



Oil cooler

To learn more about this model, call 414-764-9200 or visit giuffre.com today!

MANITEX ARTICULATING CRANES

CLASSIC

FULLY HYDRAULIC
STANDARD EQUIPMENT



Slewing by rack



4 m alarm sensor
with control panel in cab



Oil cooler



Available LC version

CLASSIC PLUS

FULLY HYDRAULIC
PLUS CONTROL & STANDARD EQUIPMENT



Slewing by rack



Proportional control valve block



Multifunction radio remote control



Oil cooler



Available LC version



6



AVAILABLE AT:

GIUFFRE.COM

GIUFFRE BROS CRANES INC.

6635 SOUTH 13TH ST. - MILWAUKEE, WI 53221
414-764-9200 • 877-321-3710

To learn more about this model, call 414-764-9200 or visit giuffre.com today!

SILVER

REACH EVEN THE HARDEST SPOTS IN COMBINATION WITH EASY ELECTRONICS



Slewing by rack



Double link



Proportional control valve block



4 m alarm sensor with control panel in cab



Oil cooler



Available LC version

GOLD

STATE-OF-THE-ART ELECTRONICS
EXTREME PRECISION



Slewing by rack



Double link



Proportional hydraulic control valve block compensated



Multifunction radio remote control



Regenerative kit



LPHV valve



4 m alarm sensor with control panel in cab



Oil cooler



Jib Multipower function



Available LC version



AVAILABLE AT:

GIUFFRE.COM

GIUFFRE BROS CRANES INC.

6635 SOUTH 13TH ST. - MILWAUKEE, WI 53221
414-764-9200 • 877-321-3710

To learn more about this model, call 414-764-9200 or visit giuffre.com today!

MANITEX ARTICULATING CRANES

PLATINUM

FIRST-CLASS PERFORMANCE
FULL PACKAGE WORKING EQUIPMENT









-  Slewing by rack
-  Double link
-  Proportional hydraulic control valve block compensated
-  Multifunction radio remote control
-  Regenerative kit
-  LPHV valve
-  4 m alarm sensor with control panel in cab
-  Oil cooler
-  Jib Multipower function
-  Available LC version
-  Available LC version MCS system for outrigger stabilizer with radio remote control



8

POWERLIFT

PERFECT FOR HANDLING WALL BOARDS
OUTSTANDING SPEED AND SAFETY

-  Slewing by rack
-  Double link
-  Proportional hydraulic control valve block compensated
-  Multifunction radio remote control with* or without display
-  LPHV valve
-  Available top seat or ground control
-  Oil cooler
-  Icon? 3 stabilizers spreads with fixed cylinder



*Available as standard on Electronic version only



AVAILABLE AT:

GIUFFRE.COM

GIUFFRE BROS CRANES INC.

6635 SOUTH 13TH ST. - MILWAUKEE, WI 53221
414-764-9200 • 877-321-3710

To learn more about this model, call 414-764-9200 or visit giuffre.com today!

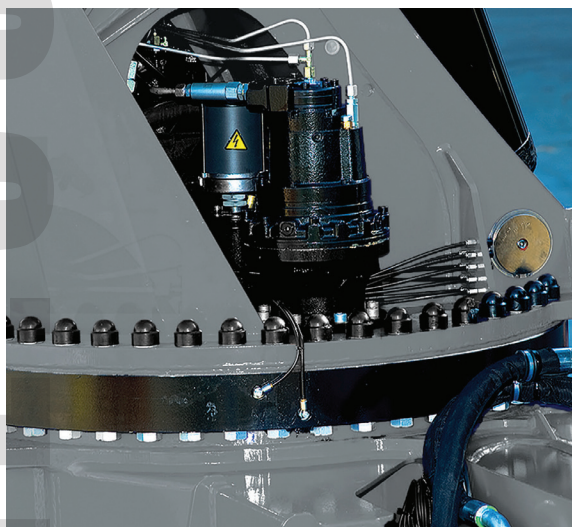

SLEWING BY RING

The crane rotation is driven by a slewing ring and a hydraulic slewing motor (gearbox).

KEY BENEFITS

- Heavy-duty operation with a high number of cycles;
- reduction of the time needed to cover the working area since the crane will never hit any dead point on the slewing circle;
- high precision on the slewing movement and low friction between the rotation gears.



DOUBLE LINK

Special connection system between column/main boom and main boom/secondary boom performing angles between 6° to 25° (depending on crane model).

KEY BENEFITS

- Lifting curve with constant movement assures high performance of the crane;
- increased operative angle for operating with more simplicity;
- ability to reach the maximum crane capacity with the boom fully extended.

To learn more about this model, call 414-764-9200 or visit giuffre.com today!

MANITEX ARTICULATING CRANES



PROPORTIONAL AND COMPENSATED HYDRAULIC VALVE BLOCK

Crane operation using a proportional compensated Valve Bank.

KEY BENEFITS

- Performs more crane functions at the same time, with movement proportional to the valve bank levers, regardless of the operative pressure of the single maneuver;
- performs simultaneous crane functions even with slow speed, using maximum operative pressure for each movement.

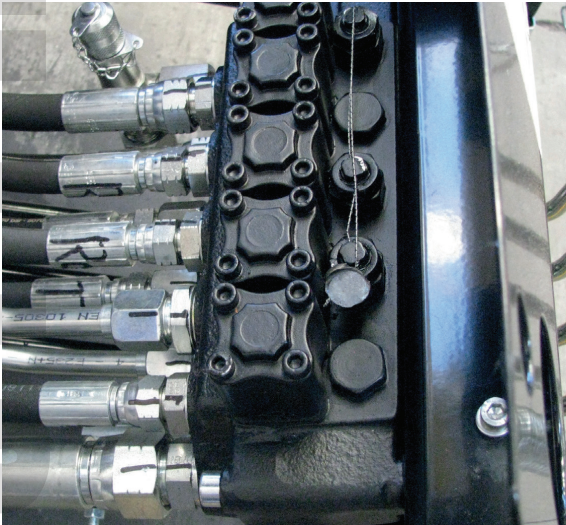

PROPORTIONAL CONTROL VALVE BLOCK

Crane operation using a proportional control Valve Bank.

KEY BENEFITS

- Assures efficient crane operation and precision movement.

10



AVAILABLE AT:

GIUFFRE.COM

GIUFFRE BROS CRANES INC.

6635 SOUTH 13TH ST. - MILWAUKEE, WI 53221
414-764-9200 • 877-321-3710



MULTI FUNCTIONAL RADIO REMOTE CONTROL WITH LCD DISPLAY

Control of the crane movement and load by a wireless radio remote control with LCD backlit screen; features frequency jumping data transfer.

KEY BENEFITS

- Increased safety during crane operation;
- keeps everything under visual control on the LCD screen: lifting ratio, pressures, temperatures, work angle and more;
- indication and analysis of overload status either on column cylinder, main boom cylinder, jib or winch;
- the backlit display allows full visibility and information even operating the crane at night;
- the frequency jumping system allows continuous change of frequencies between transmitter and receiver, limiting potential interruption from electromagnetic interferences and allowing the job to be safely performed.



PM POWER TRONIC ADVANCE

Crane operative system with information on LCD display.

It's easier to operate the crane, because:

- lifting condition of the crane is always visible;
- lifting capacity is always visible.

OTHER BENEFITS:

- self-diagnostic of the system in real time;
- high sensitivity and precision with single or multiple maneuvers.

To learn more about this model, call 414-764-9200 or visit giuffre.com today!

MANITEX ARTICULATING CRANES

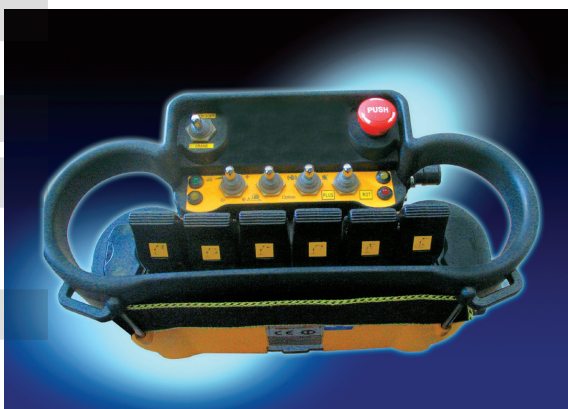

MULTIFUNCTIONAL RADIO REMOTE WITHOUT DISPLAY

Control of the crane movement and load by wireless radio remote control; features frequency jumping data transfer. Also available is the radio palm transmitter, which is a more economical and easy-to-use option. (MAC 3P, MAC 3.9P, MAC 5P only).

KEY BENEFITS

- Operates the crane from a distance with maximum safety;
- the frequency jumping system allows continuous change of frequencies between transmitter and receiver, limiting potential interruption from electromagnetic interferences and allowing the job to be safely performed.



PM STABILITY POWER SYSTEM

(MANDATORY FOR CRANES THAT COMPLY TO CE STANDARDS)

Stabilizer monitor system designed according to EN 12999 standard. The system automatically sets the maximum lifting capacity of the crane according to the spread of the stabilizers. The stabilizer spread status is also shown on the Power Tronic LCD display and on the MCS system.

KEY BENEFITS

- This system delivers maximum safety because the crane is utilized at its maximum capacity to the set stability.



MCS SYSTEM FOR OUTRIGGER STABILIZERS WITH RADIO REMOTE CONTROL

The system features a control panel for the manual operation of the outrigger stabilizers through soft switch. It is also equipped with indicator lights that confirm the deployment status of the stabilizers on the ground.

KEY BENEFITS

- Increased operative safety;
- immediate visualization of the stabilization status even operating the crane at night.

To learn more about this model, call 414-764-9200 or visit giuffre.com today!

MANITEX ARTICULATING CRANES



JIB MULTIPOWER SYSTEM

According to the working configuration, and in particular to the angle between the jib and the secondary booms, this system automatically modifies the maximum pressure setting of the cylinders, making the most of the structural resistance.

KEY BENEFITS

- The maximum lifting capacity of the jib can be reached at any working configuration.

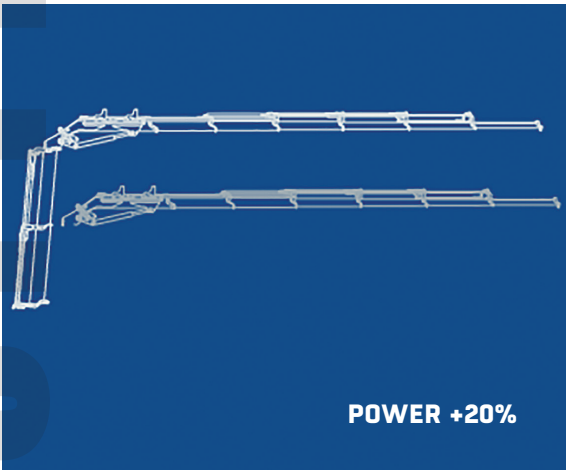

JIB MULTIPOWER SYSTEM PLUS

This system adds to the jib multipower two overload settings that work according to the extension of the crane boom.

KEY BENEFITS

- The jib lifting capacity is optimized even when crane secondary booms are not fully extended and at any boom angle configuration.



4 MAXIMUM TRAVEL ALARM SENSOR WITH CONTROL PANEL IN THE CABIN

Sensor that monitors the maximum travel high of the vehicle with the crane folded in transport position.

KEY BENEFITS

- Allows crane to be transported with maximum safety;
- A control panel located in the truck cabin uses visual and acoustic alarms to alert the driver if the height of the crane goes above the legal limit (4 mt / 13'6").

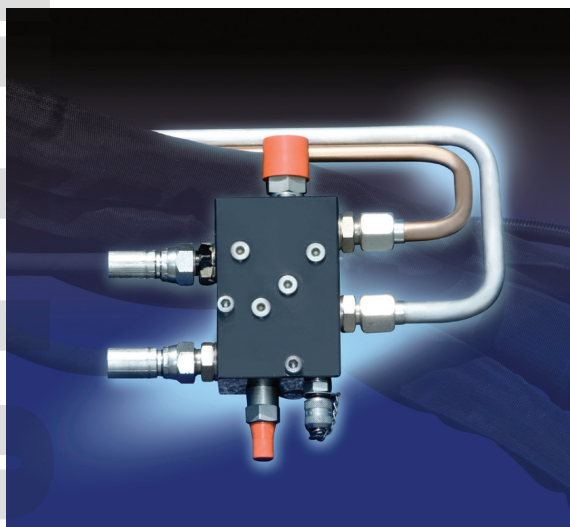

REGENERATIVE VALVE

Regenerative hydraulic circuit installed on the extension cylinders. The valve recycles the oil coming out from the rod outlet (that is directed to the oil tank) by sending it back to the cylinder bottom, accelerating the movement.

KEY BENEFITS

- Improves working productivity by increasing cylinder speed.

MANITEX ARTICULATING CRANES



**LPHV VALVE
(LOW PRESSURE HOLDING VALVE)***

Balancing valve on lifting cylinders.

KEY BENEFITS

- Linear and precise lifting movement, independent from the lifting load with reduced oscillations during work operation.

* A.K.A. LPW and WRBC valve

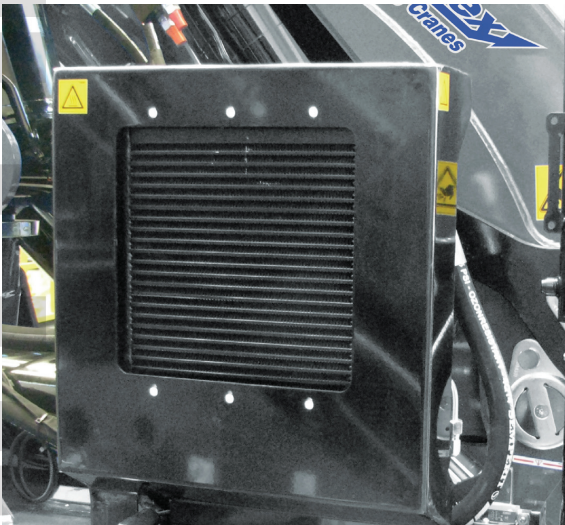

OIL COOLER

A light and compact oil cooler that reduces the oil temperature during crane operation. It can be installed on the crane, under a protective cover.

KEY BENEFITS

- Extends the lifecycle of cylinder gasket, hydraulic valves and all other hydraulic components of the crane;
- longer lifecycle for the hydraulic oil;
- enables the crane to operate in hot climates and perform heavy working cycles;
- Allow the use of a smaller oil tank, reducing then the crane weight and increasing payload.



LC VERSION

Retractable telescopic system installed on the boom pack.

KEY BENEFITS

- Facilitates handling of bulky loads within a short radius, allowing loads to be loaded under the column for increased efficiency.

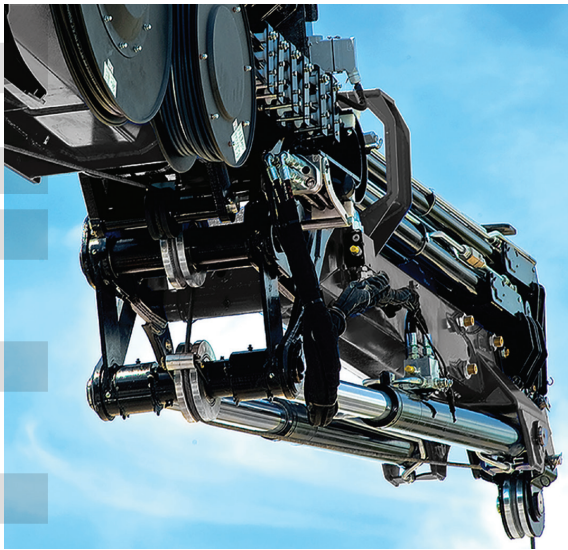

WINCH

Hydraulic winch to be installed on the basic crane or jib. Available in versions from 500 Kg to 5000 Kg depending on the crane size.

KEY BENEFITS

- Prevent structural damages with just-in-time control of the lifted load;
- handles the load with maximum precision;
- an alarm signal indicates overload condition and the anti-two block engagements (in case of electronic controlled winches);
- compensate crane oscillations for better stability control;
- the new pulley system with rollers centered on the axle of the crane and jib allows the crane to be folded armed with pulleys, for faster folding time (available on some models only);
- more compact, requiring a smaller installation area.

To learn more about this model, call 414-764-9200 or visit giuffre.com today!

MANITEX ARTICULATING CRANES

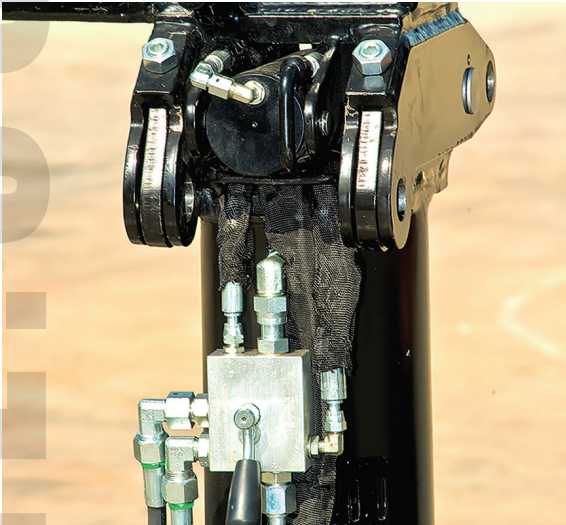

ROTATING HYDRAULIC STABILIZERS

The cylinder stabilizers can rotate manually or hydraulically from 90° to 180° depending on the crane model.

KEY BENEFITS

- The crane can be installed directly on the truck axle regardless of other equipment under the frame like hydraulic tanks, tool boxes, etc;
- easy to maneuver;
- eliminates the potential risk of collision between the stabilizer cylinders and the ground, also in presence of irregular roads.



TILTING STABILIZER PLATE

The stabilizer plate has an inclination of 10°.

KEY BENEFITS

- The tilting stabilizer plate adapts to the ground inclination for optimal stability;
- the wider plate dimensions better distribute the weights on the ground.

To learn more about this model, call 414-764-9200 or visit giuffre.com today!



SUPPLEMENTARY ACTIVATIONS

Supplementary activation with hose reel or hose track including a hydraulic line on the side of the boom reaching the tip of the crane.

KEY BENEFITS

- Offers the possibility to use supplementary functions such as Jibs or other hydraulic accessories.



WORKING LAMP WITH LED TECHNOLOGY

High-power working lamp with LED technology.

KEY BENEFITS

- Allows operators to perform a job at night with high- level illumination at low costs.



To learn more about this model, call 414-764-9200 or visit giuffre.com today!

MANITEX ARTICULATING CRANES



INTEGRAL BASE

Custom-made base that replaces the crane sub-frame. Standard on the MAC 150 and MAC 210 models.

KEY BENEFITS

- Reduces the height and the weight of the installation;
- lowers the center of gravity for better installation stability;
- reduces the torsional effect on the sub-frame for a better installation stability;
- reduces installation costs.



JIB

Jib with double articulation cylinder, available on different configurations according to the required crane size.

KEY BENEFITS

- Increases the crane reach;
- addresses more applications;
- provides more operational flexibility on the house roof and in situations with difficult access thanks to the negative angle (up to 25° depending on crane model).



STABILIZER WARNING LIGHTS

LED indicator located on the cylinder stabilizers indicating when the crane is operating.

KEY BENEFITS

- Improved visibility of the position of the stabilizer cylinders and better safety for the operators and anybody in the working area.



SEQUENTIAL BOOM EXTENSION

Control system for the sequential boom extensions.

KEY BENEFITS

- Ideal distribution of the static solicitation on the extensions and optimized weight distribution on the structure;
- system integrated on the extension cylinders, with space reduction.

To learn more about this model, call 414-764-9200 or visit giuffre.com today!

MANITEX ARTICULATING CRANES



TOP SEAT

Top seat control station to maneuver the crane.

KEY BENEFITS

- Better visibility of loading operations.

ANTI-CORROSION PROTECTION SYSTEMS

Special structural treatment on Zinc base and paint coating on the crane area with high exposure to salt fog.

KEY BENEFITS

- Improves corrosion resistance.

CERTIFICATIONS & WARRANTY



In accordance with EU safety standards



In accordance with H1-B3 standard



3-years warranty on the structural parts



Quality certification UNI EN ISO 9001:2008



Certified Painting System

To learn more about this model, call 414-764-9200 or visit giuffre.com today!

COMPLETE RANGE OF ACCESSORIES

FOR EVEN MORE APPLICATIONS



Operator basket and self-levelling platforms



Pallet forks



Swivel hooks

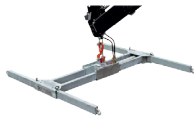

Cross beams for car lifting



Clamshell buckets



Log grabs



Brick grabs



Augers



Supplementary outrigger



Hydraulic rotors



Hydraulic grapples



Variable hydraulic pumps



Fixed hydraulic pumps

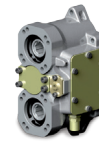

PTO

To learn more about this model, call 414-764-9200 or visit giuffre.com today!



MANITEX, INC.

MANITEX, INC. 3000 S. AUSTIN AVE.
GEORGETOWN, TX 78626
TEL: (512) 942-3000
FAX: (512) 863-3776

Technical data can be revised without prior notice



AVAILABLE AT:

GIUFFRE.COM

GIUFFRE BROS CRANES INC.

6635 SOUTH 13TH ST. - MILWAUKEE, WI 53221
414-764-9200 • 877-321-3710